

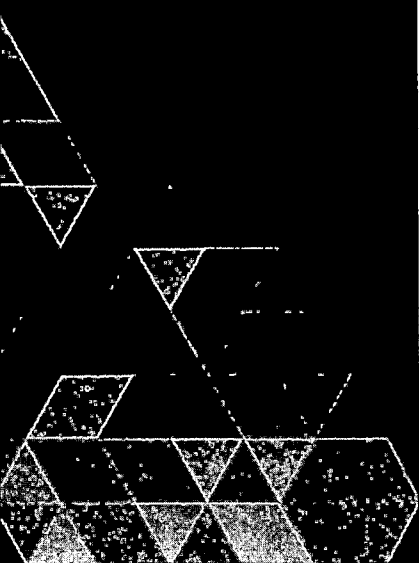

COMMERCIAL OFFERS FOR JOINT PROJECTS IMPLEMENTATION ALMATY CITY.

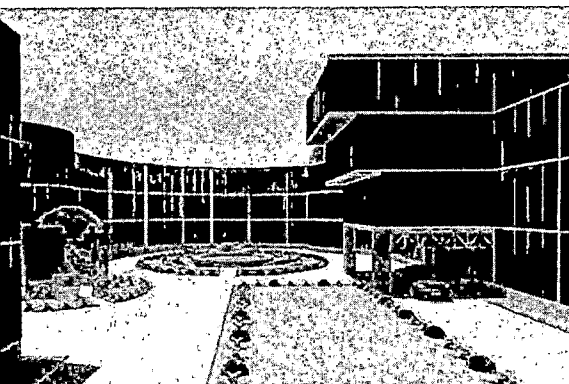

BUS STATION CONSTRUCTION

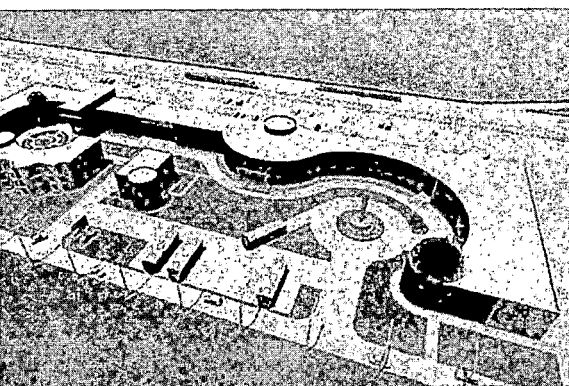
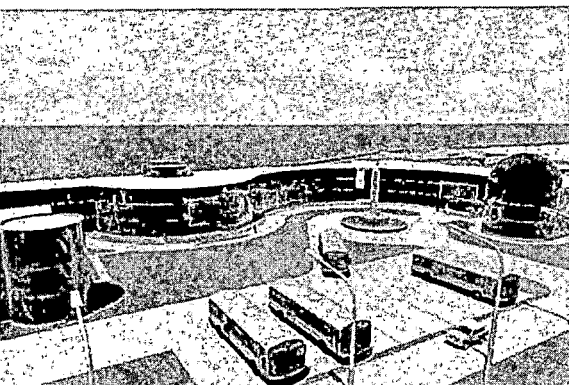

The purpose of the project: The construction of bus station "Western" and "Eastern" to improve the quality of service for passenger traffic, to reduce traffic jam and improve the environmental situation in Almaty.



Implementation Period: 2016 – 2019 years



Location: Almaty City, Alatau District and Medeu District.



Required investments: 112,4 mln. dollars. US



Employment creation: 529 people



Total Bus Station capacity: 4500 passengers per day. Capacity - 1400 passengers. Hotel - 120 rooms.

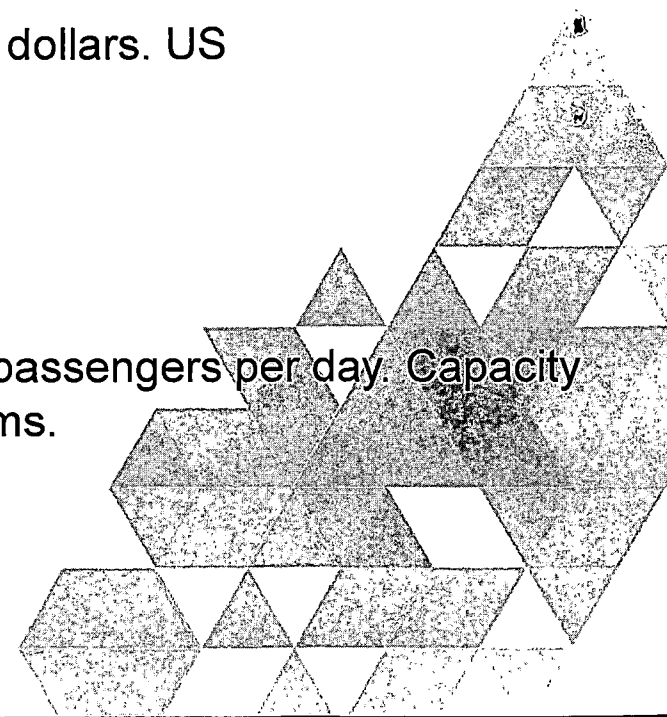

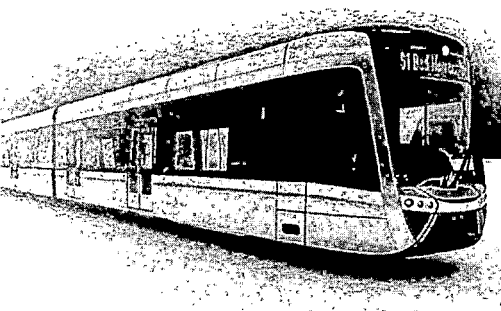
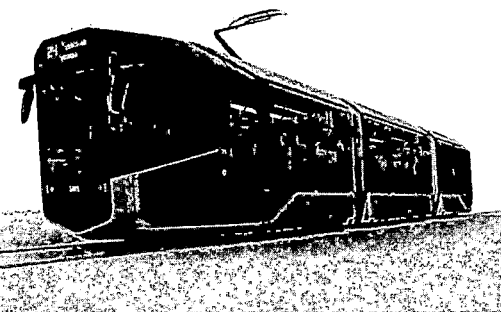
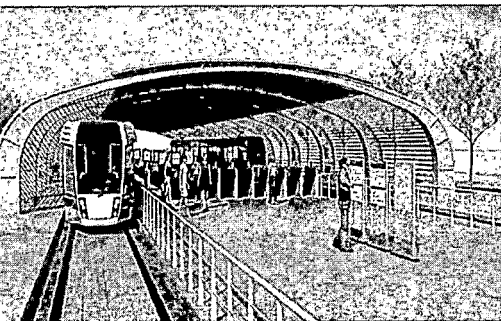

The purpose of the project: The providing of ecological and comfortable transportation for passengers.



Implementation Period: 2018 – 2020 years



Required investments: 310 mln. dollars. US



Payback period: 5 years



Transportation capacity: 35 mln. Passengers per year



Employment creation: 476 people



Infrastructure and resources: LRT route length is 22.905 km.
Total number of Tram stations - 66 units. LRT maintenance depot and rolling-stock storage.
Construction volume of project - 123,345 m³ Rolling-stocks 31 units.

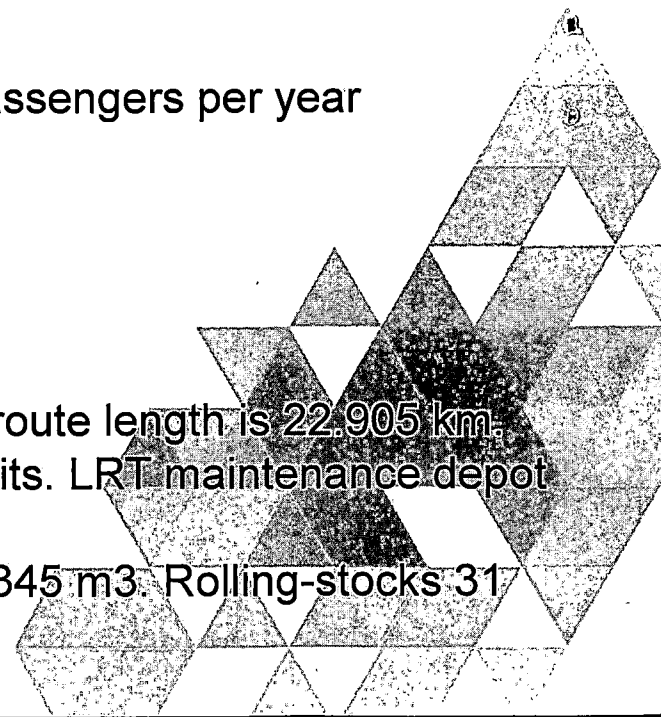

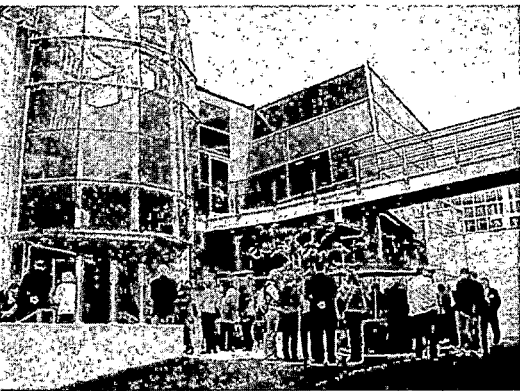
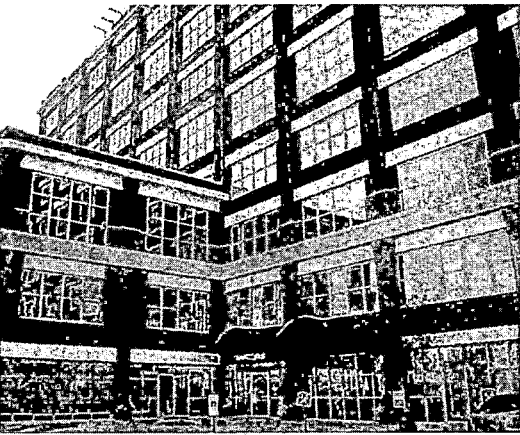

The purpose of the project: Construction of College with a modern technical base, focused on training in the field of industry and innovation.



Implementation Period: 2016 – 2020 years



Required investments: 150 mln. dollars. US



Payback period: 10 years



Benefits:

1. The shortage of staff in the field of industrial and innovative development
2. The state order for training



Employment creation: 500 years

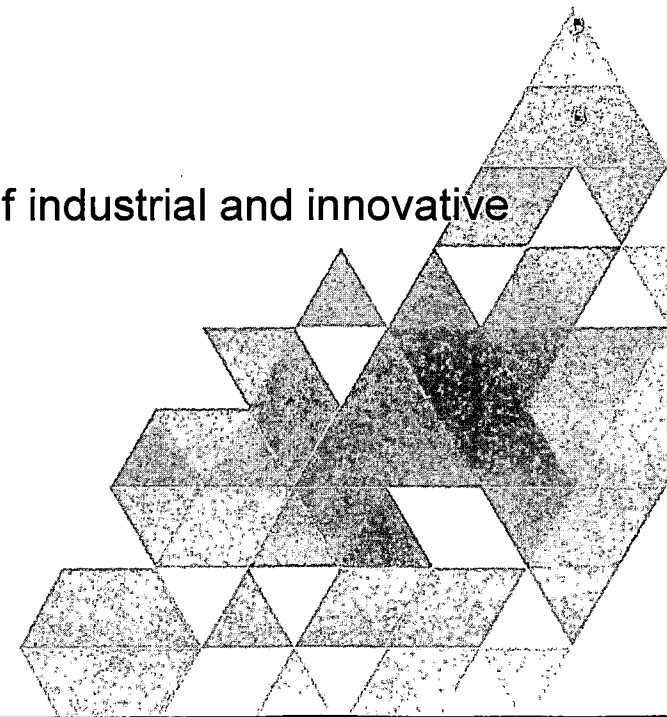

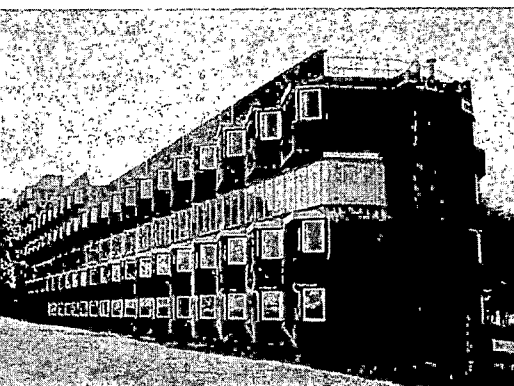

The purpose of the project: Construction of student dormitory



Implementation Period: 2016 – 2020 years



Required investments: 50 mln. dollars. US



Payback period: 7 years (rent 20 years)



Need: Shortage of comfortable student dormitories in the city



Employment creation: 100 people during construction

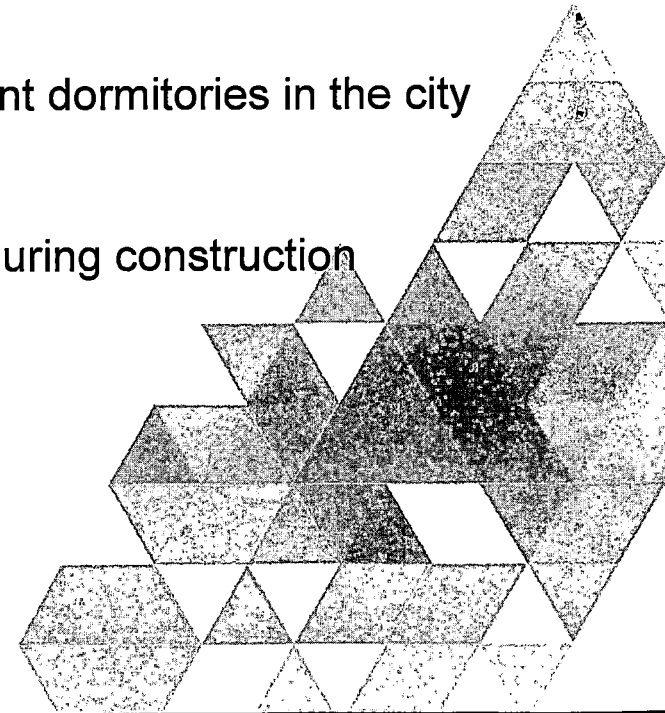

CONSTRUCTION OF ETHNIC VILLAGE

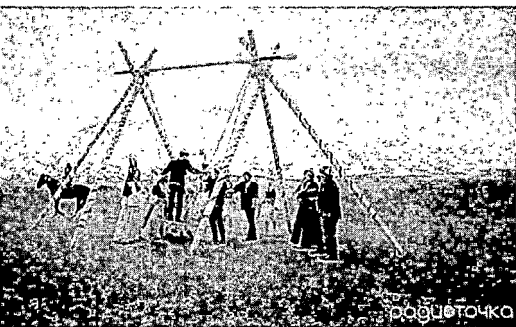

The purpose of the project: Construction of ethnic village in an attractive area for tourists



Implementation Period: 2016 – 2018 years



Required investments: 8,1 mln. dollars. US



Payback period: 6 years



Need: Lack of Cultural Center for rest



Employment creation: 150 people

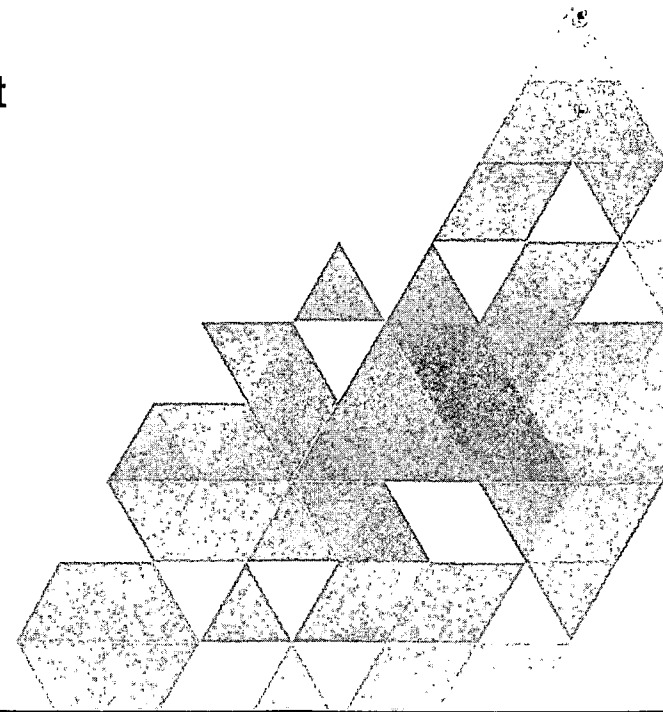



The purpose of the project: Cleaning the urban pond "Sayran."
Reconstruction of the beach and creation the infrastructure for fashionable restaurants



Implementation Period: 2016 – 2018 years



Required investments: 43 mln. dollars. US



Payback period: 10 years



Employment creation: 1200 people

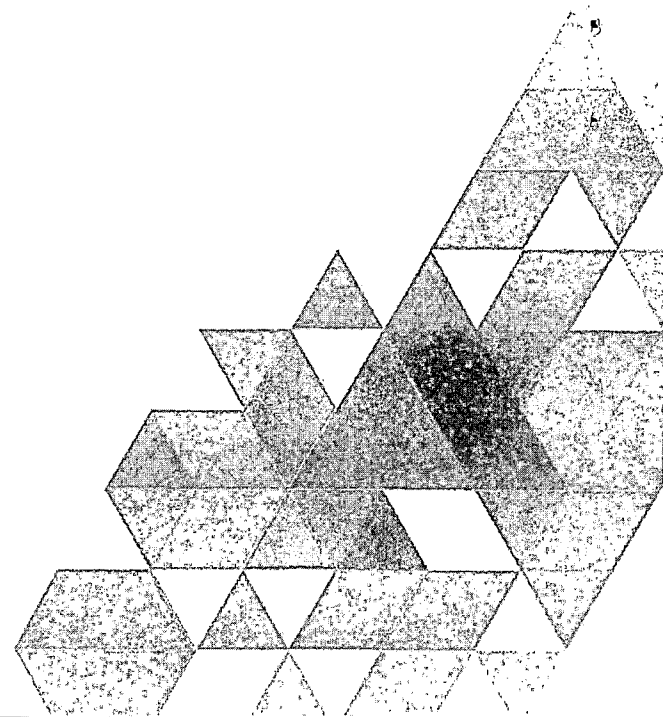



CONSTRUCTION OF GREENHOUSE COMPLEX

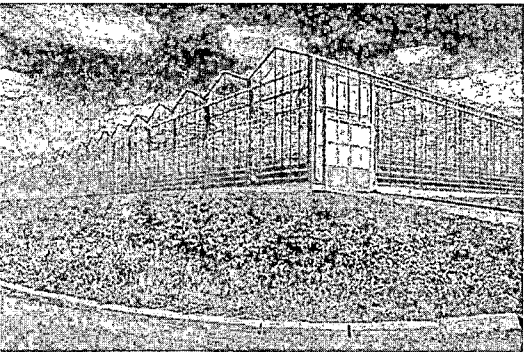
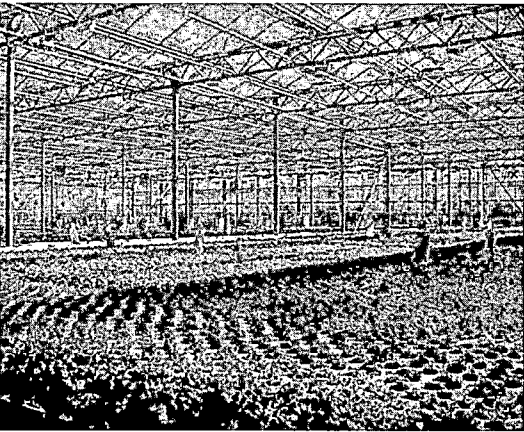
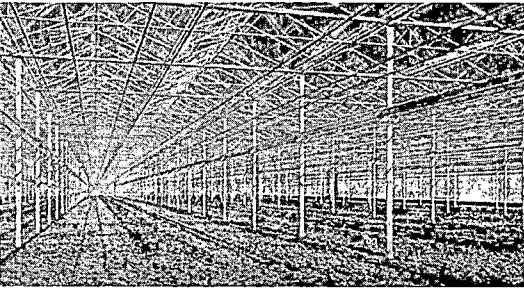

The purpose of the project: Construction of Greenhouse Complex



Implementation period: 2016 – 2018 years



Required Investments: 70 mln. dollars. US



Payback period: 5-6 years



Need: New modern complex occupies 14% of the total number of greenhouses Almaty. The average import dependence vegetable market is 70%. Requires 100-hectare greenhouse complex for the city.



Employment creation: 30 - 40 years

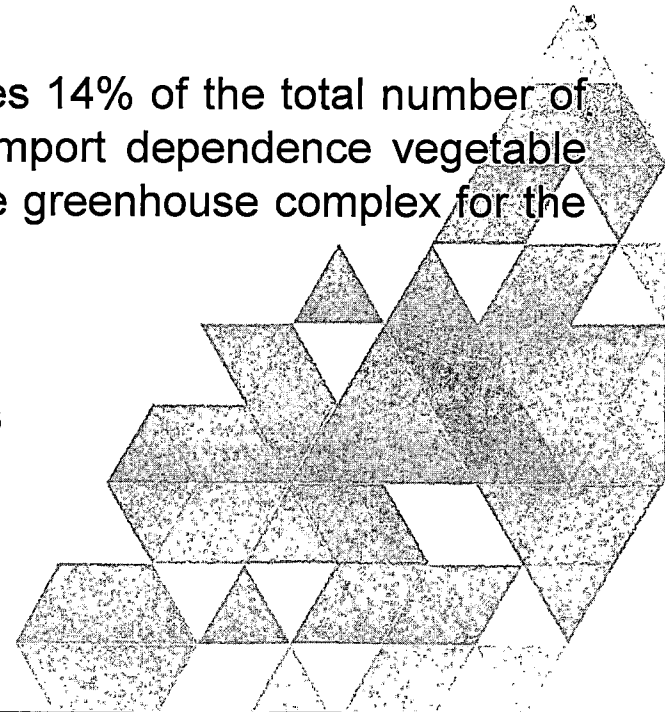

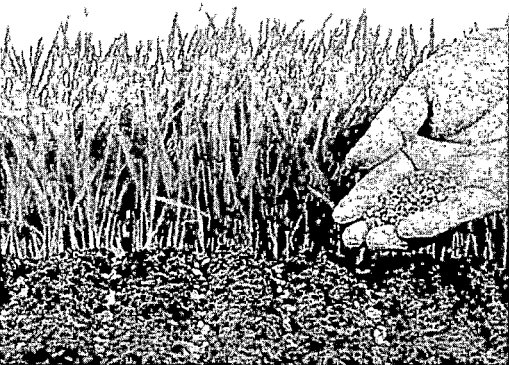
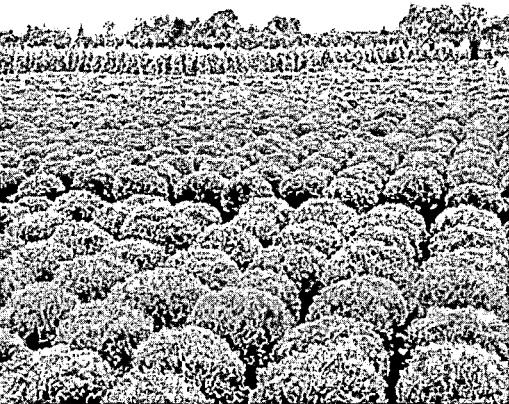

The purpose of the project: Organization of rearing live plants, including their roots



Implementation period: 2016 – 2017 years



Required Investments: 7 mln. dollars. US



Payback period: 3 years



Need: Import of plant for 10 months in 2015 amounted to 4.3 million. dollars. US



Employment creation: 20 – 30 people

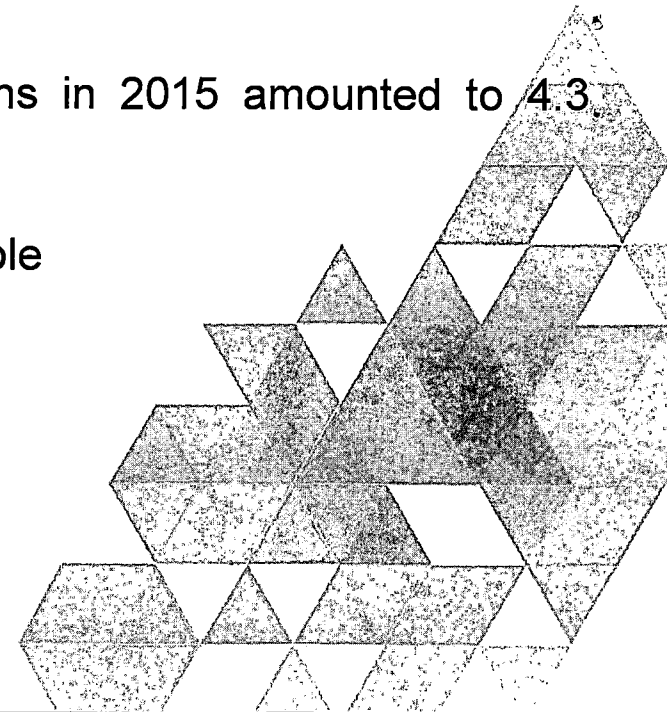

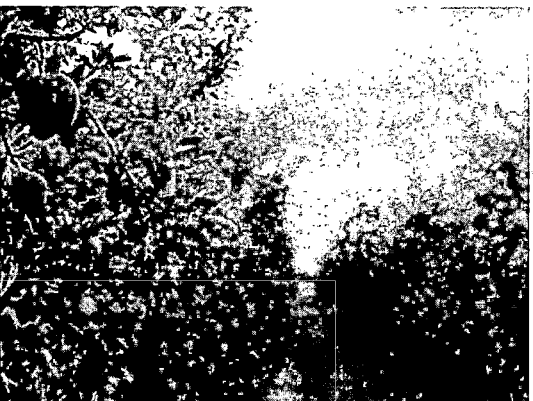

The purpose of the project: Growing industrial varieties of apples using drip irrigation technology to meet the needs of Almaty and other regions of Kazakhstan



Implementation period: 2016 – 2020 years



Required Investments: 10 млн. dollars. US



Productivity: 18 thousand tons per year



Payback period: 8 years



Employment creation: 500 people



Need: Import of apples and pears for 10 months of 2015 amounted to 7.7 million. dollars. US

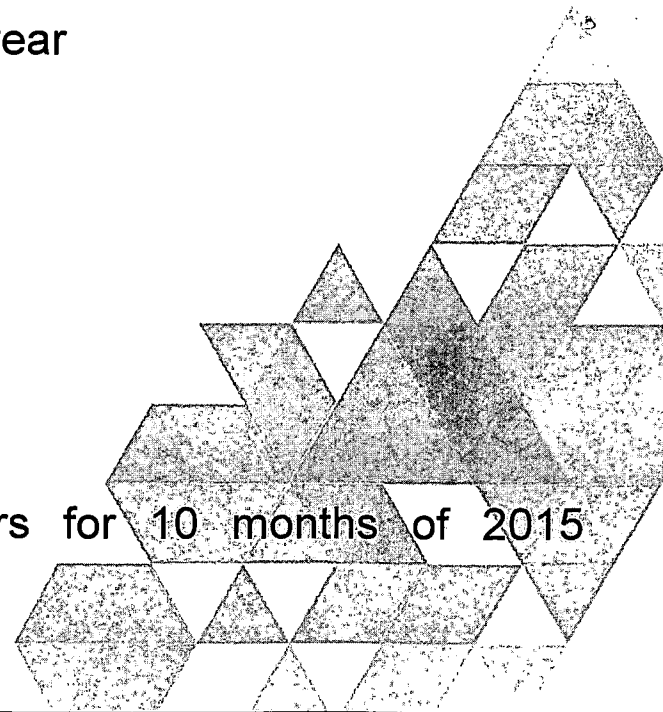



CONSTRUCTION OF LOGISTIC GOODS COMPLEX

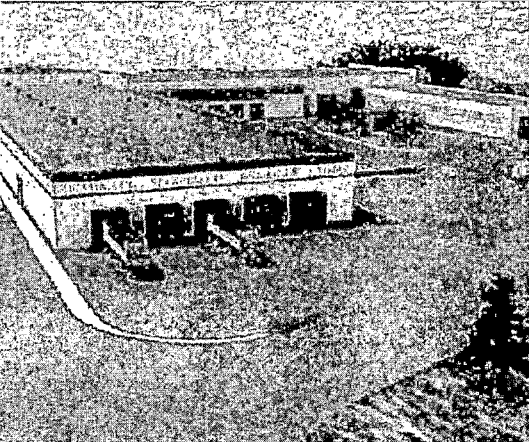

The purpose of the project: Create the food wholesale platform with a developed infrastructure of storage, transportation, sorting and labeling of agricultural products



Implementation period: 2015 – 2016 years



Required Investments: 25 mln. dollars. US



Payback period: 8 years



Benefits:

- 1. Lack of capacities for storing vegetables
- 2. The growth of consumption by the population of the city
- 3. Expansion of export potential



Employment creation: 200 work places.

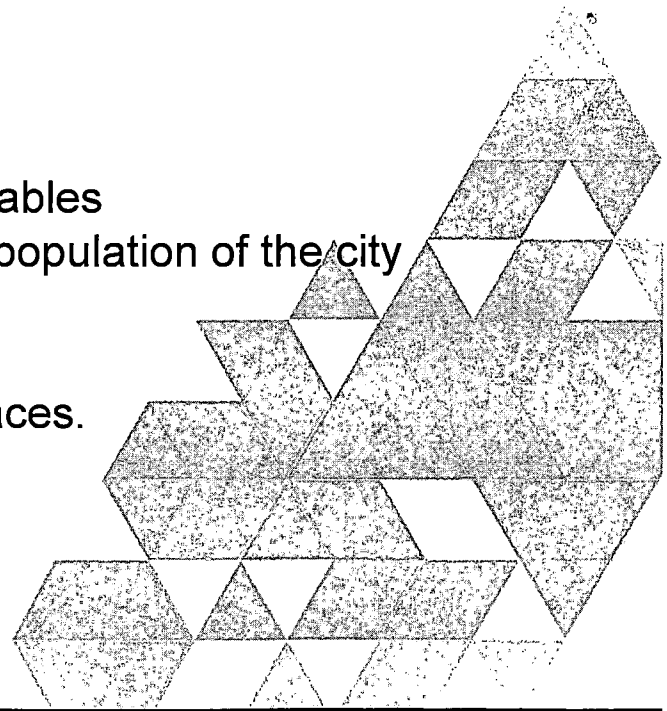



CONSTRUCTION OF WHOLESALE MARKET AND LOGISTICS MARKET



The purpose of the project: Construction of the wholesale market of agricultural products with an extensive logistics system by analogy of the French market "Randzhis"



Implementation period: 2016 – 2020 years



Required Investments: 100 mln. Dollars. US



Trade line construction: is to be more than 3,000 retail outlets places





PROJECT AND INVESTIBLE PROCESSING

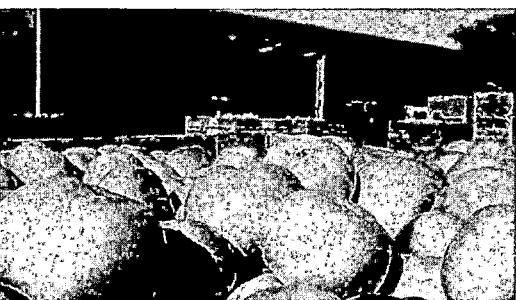
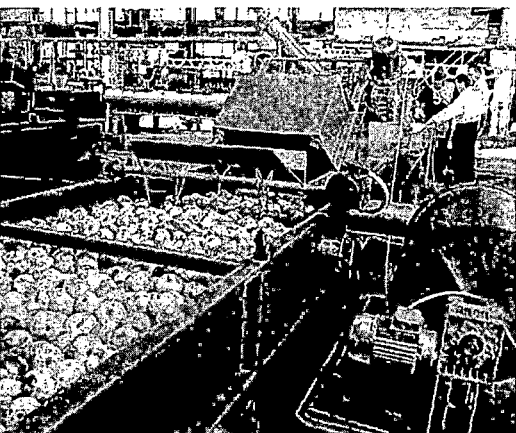

The purpose of the project: To construct a new factory of production of jam



Implementation period: 2016 – 2017 years



Required Investments: 4 mln. dollar. US



Productivity: 2 tons of products per month



Payback period: 18 – 24 month



Employment creation: 20 people

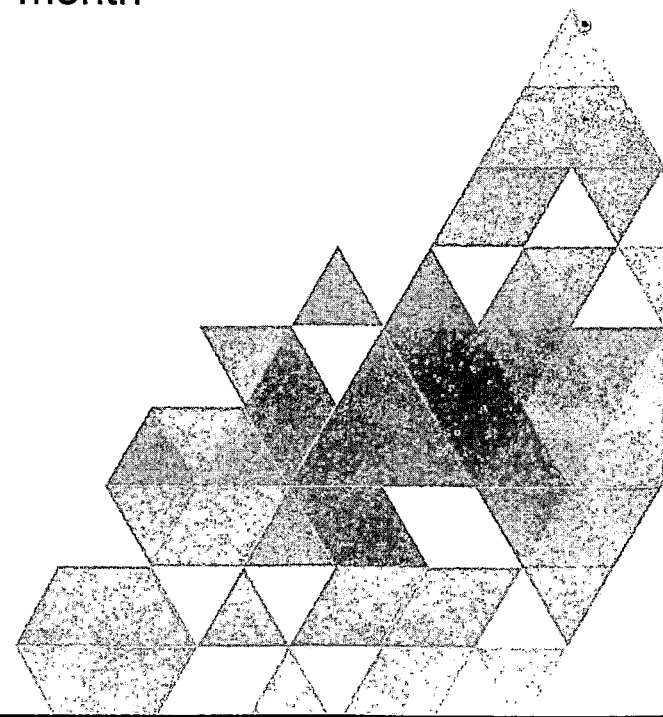

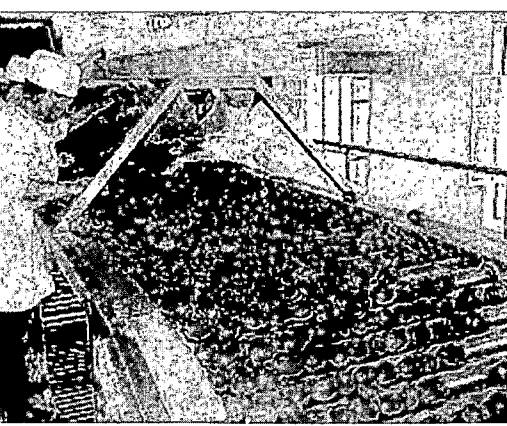

The purpose of the project: To construct factory for canning vegetables and tomato products



Implementation period: 2016 – 2018 years



Required investments: 3 mln. dollars. US



Payback period: 5 years



Need: Imports of canned vegetables within the 10 month of 2015 was amounted of 19 million. dollars. US



Employment creation: 50-55 people

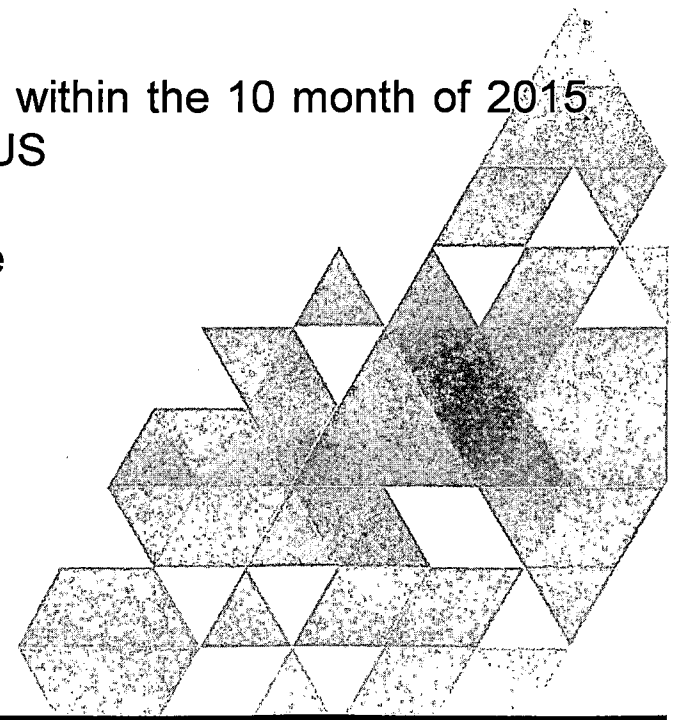



The purpose of the project: Meat Processing. Freezing and cooling. Packaging and labeling into vacuum bags. With further export.



Implementation period: 2016 – 2017 years



Required Investments: 11 mln. dollars. US



Productivity: 10 tons per days



Payback period: 2 years



Employment creation: 40 people

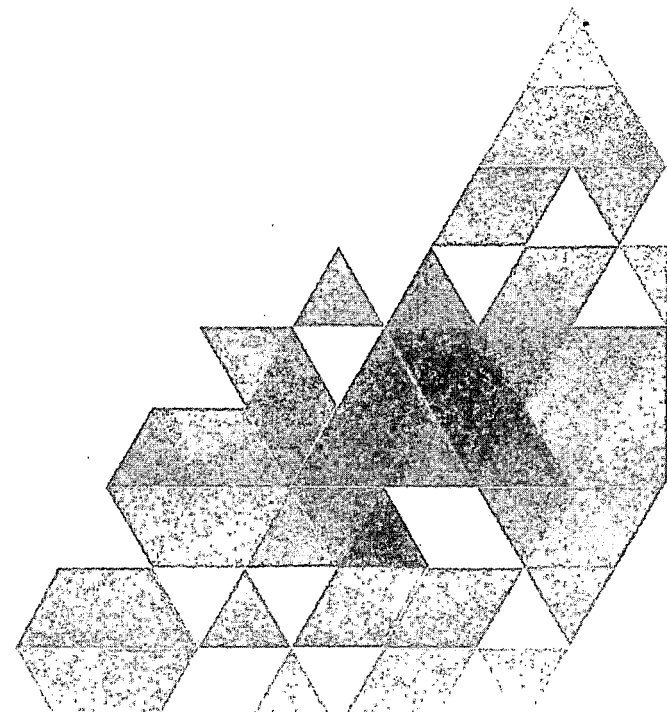

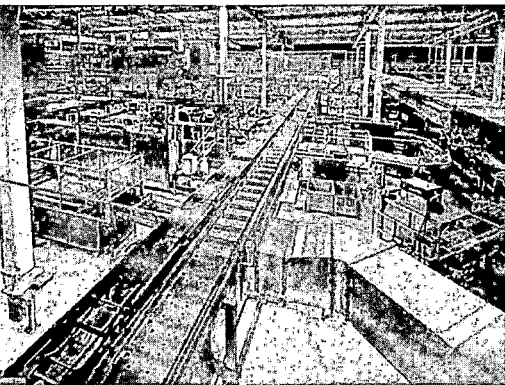

The purpose of the projects: Production of fermented dairy products such as yogurt, cream etc. Including cheese, cottage cheese and margarine production



Implementation period: 2016 – 2017 years



Required Investments: 7 mln. dollar. US



Payback period: 4 years



Need: imports of fermented milk products within 10 month in 2015 was in amount of 32.3 million USD



Employment creation: 180 people

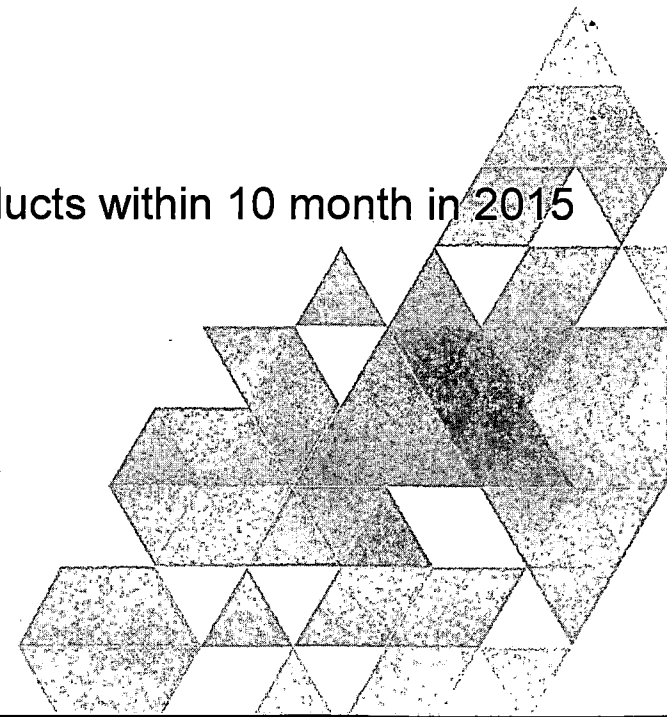

PRODUCTION OF CANNED CONDENSED AND NOT CONDENSED MILK

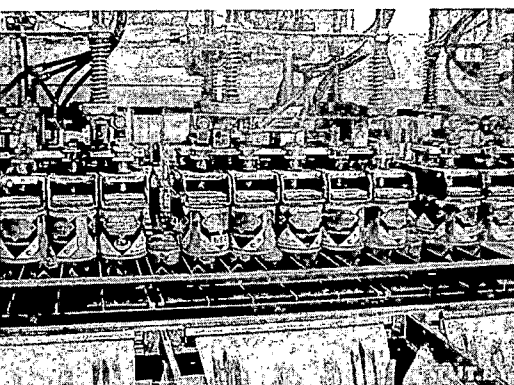
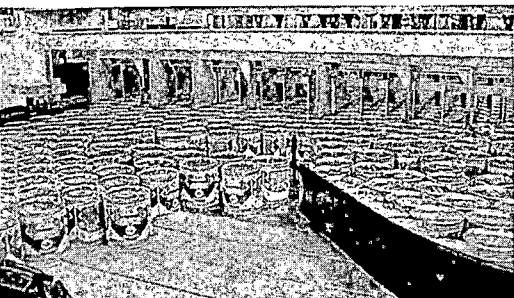

The purpose of the project: Production of canned evaporated or condensed milk with different fat content



Implementation period: 2016 – 2018 years



Required Investments: 3 mln. dollars. US



Payback period: 3 year



Need: Imports of canned evaporated or condensed milk within ten month period in 2015 was in amount of 26.3 million USD



Employment creation: 50 people

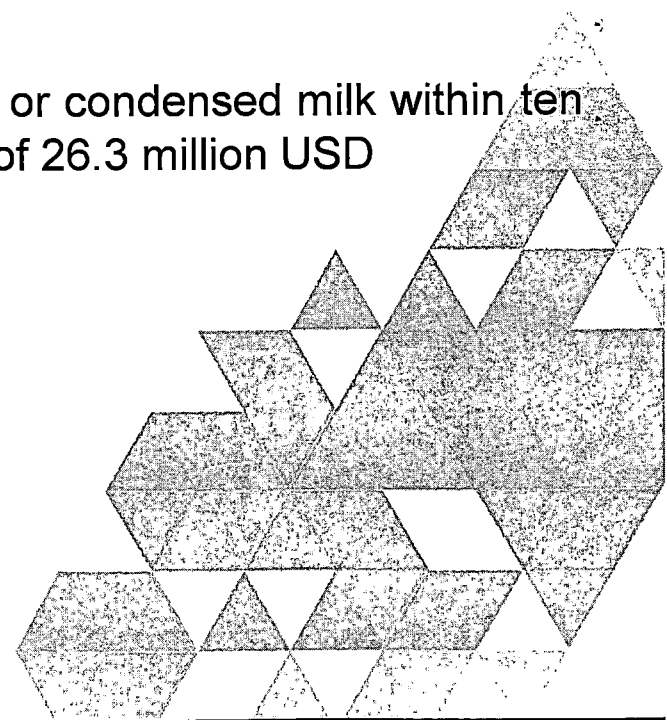



CONFECTIONERY

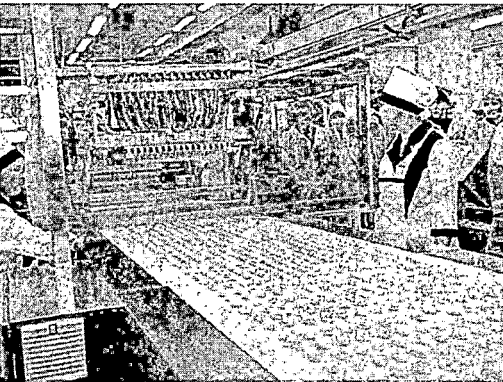
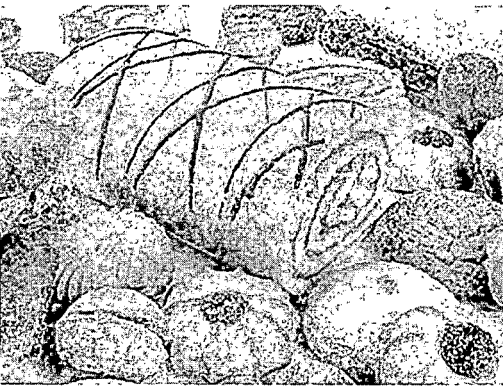

The purpose of the project: To construct the factory of the confectionery and chocolate production



Implementation period: 2016 – 2017 years



Required Investments: 20 mln. dollars. US



Payback period: 3,5 – 4 years



Need: imports of confectionery products for the period of 10 months in 2015 was in amount of 31.2 million USD



Employment creation: 1500 people

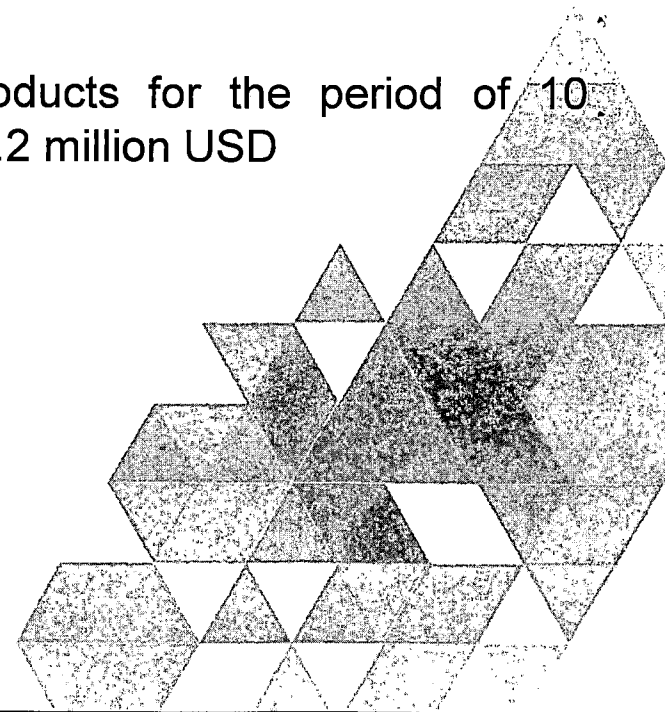

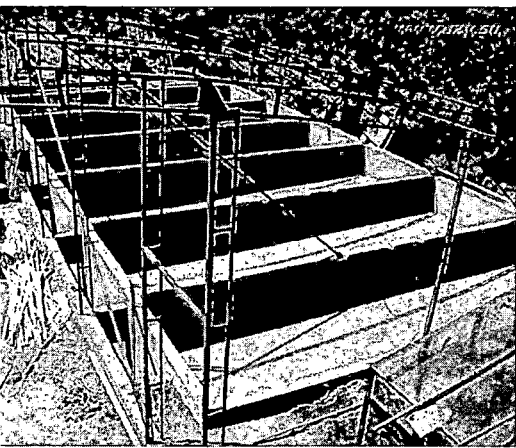
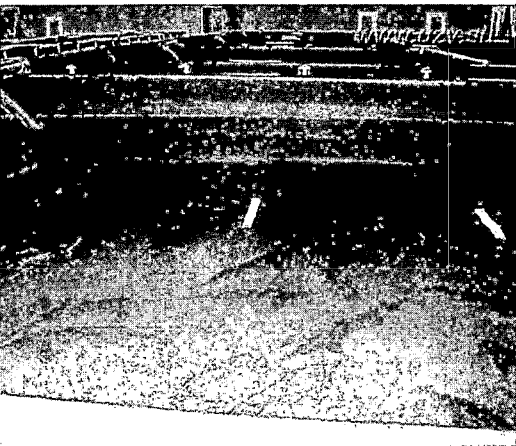

The purpose of the project: Production and processing of lake-commercial fish



Implementation period: 2016-2017 years



Required Investments: 5 mln. dollars. US



Payback period: 5 years.



Advantage:

- the existence of pond and lake farms;
- the growing demand for products
- import substitution; In accordance with ten month period result the imports in Almaty was 7 million USD

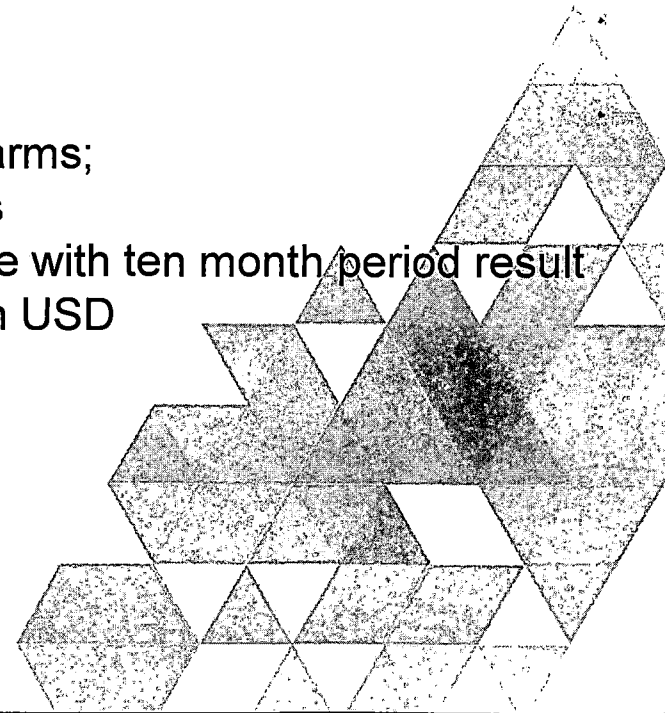

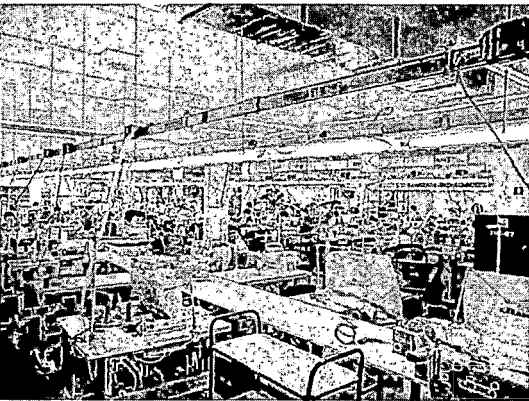

The purpose of the project: To construct clothing manufacture to produce cloth and footwear



Implementation period: 2016 – 2017 years



The scheme of implementation: Establishment of joint venture by attracting investment



Required Investments: 10 mln. dollars. US



Payback period: 4 – 5 years.



Advantage:

1. The implementation of the new modern technology in the clothing manufacture
2. Capacious market within the period from January to October of 2015 in Almaty City was 194.9 mln of imported clothes and imported shoes was in amount of 169.8 mln USD



Employment creation: 150 work places

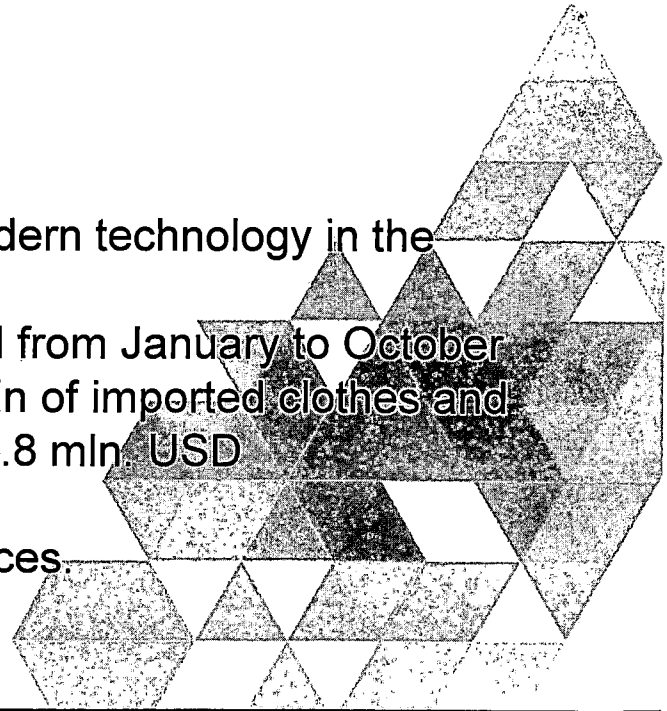

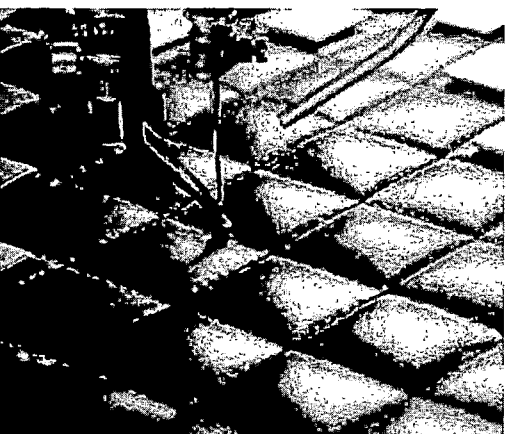

EXPOSICIÓN



The purpose of the project: Production of bags, suitcases, school bags, cases



Implementation period: 2016 – 2018 years



Required Investments: 3,5 – 4 mln. dollars. US



Payback period: 4 years.



Need: Import of bags, suitcases for the period of 10 months in 2015 was in amount of 42.4 million USD



Employment creation: 60 people

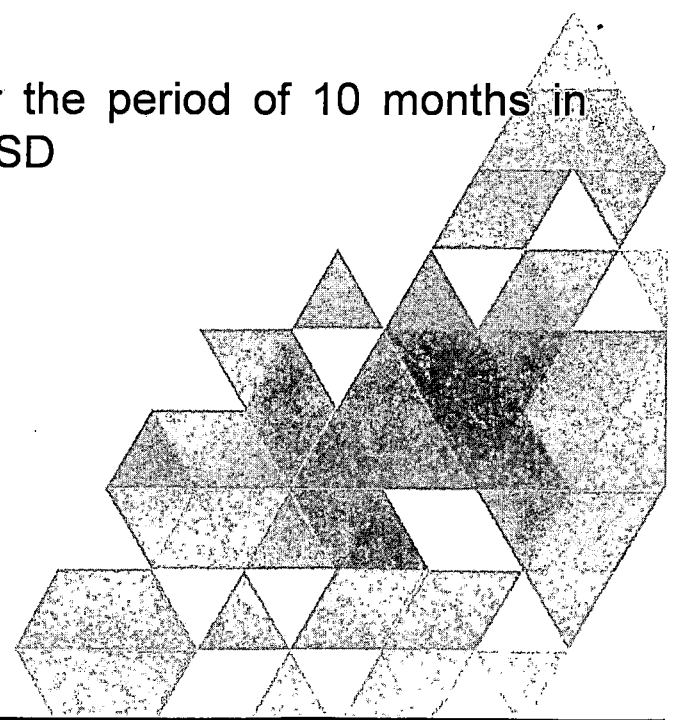

MANUFACTURE OF PAPER AND PAPER PRODUCTS

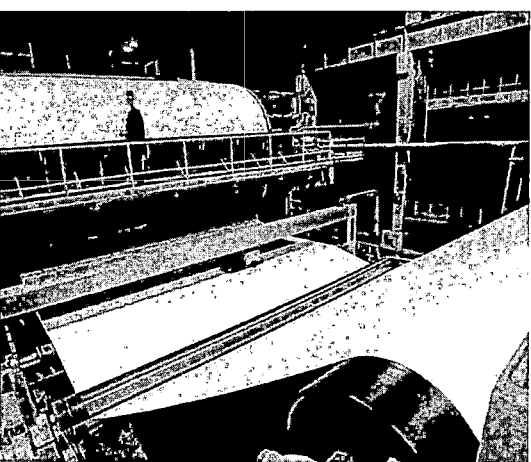
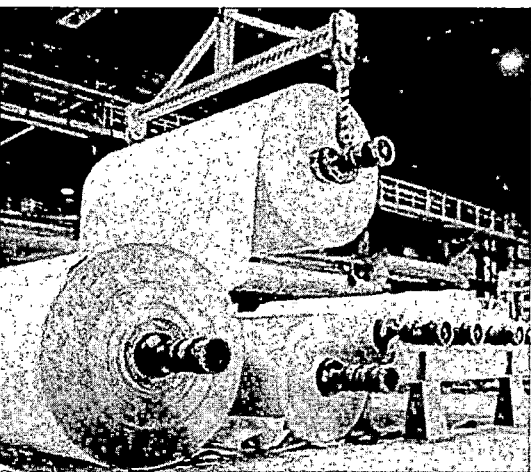
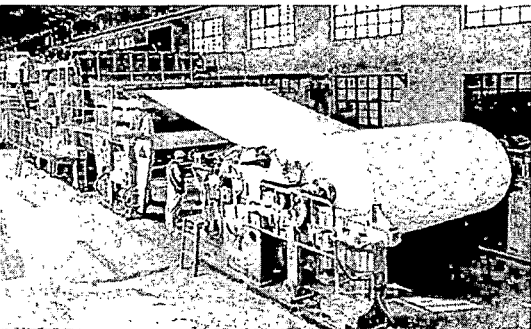

The purpose of the project: To construct the factory to produce paper, corrugated cardboard, paper and cardboard packaging, cardboard products



Implementation period: 2016 – 2017 years



Required Investments: 12,8 mln. dollars. US



Productivity: 50 million. Paper bags per year



Need: imports of paper products for the period of 10 months in 2015 was in amount of 28.2 million US



Employment creation: 120 people

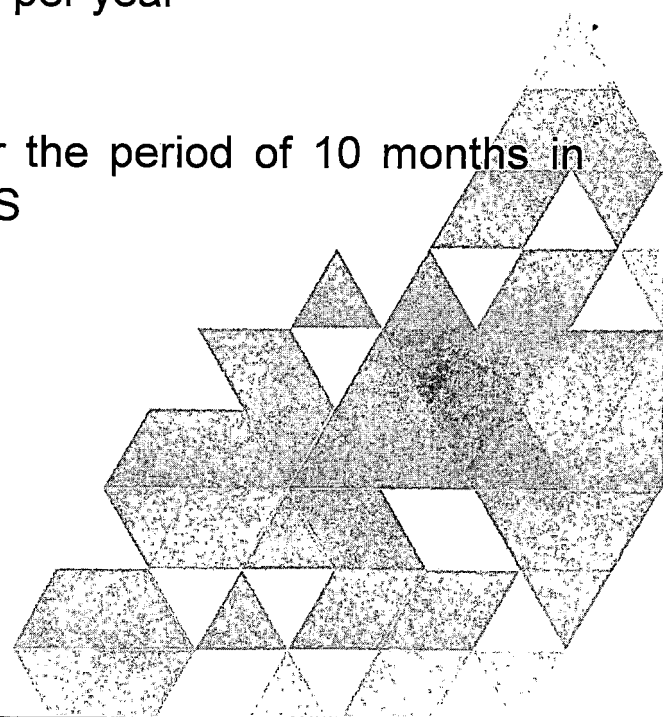

MEDICINES PRODUCTION

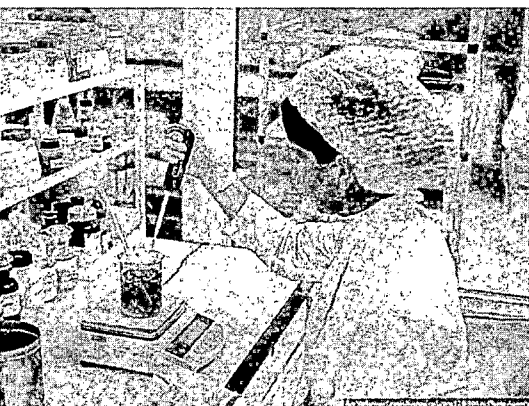

The purpose of the project: Construction workshops of the medicine production



Implementation period: 2016 – 2017 years



Required Investments: 2,8 mln. dollars. US



Payback period: 5 years



Need: Imported drugs for the period of 10 months in 2015 was in amount of 490 million USD



Employment creation: 30 people

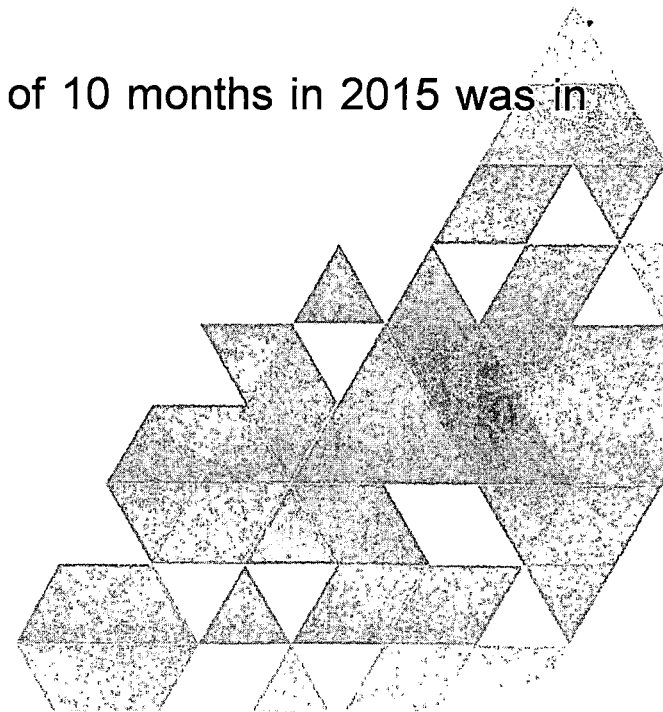

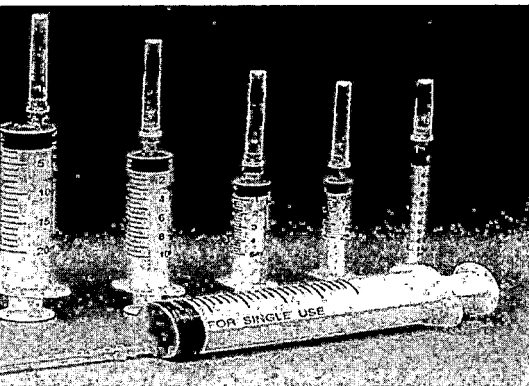
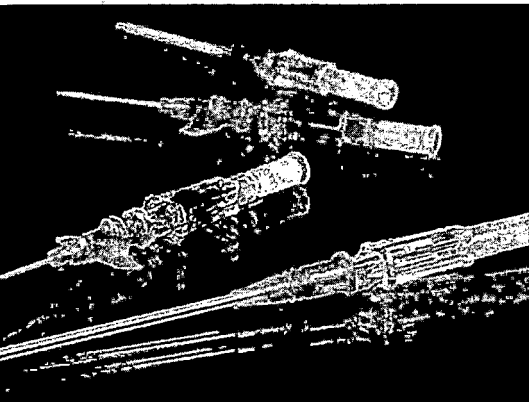
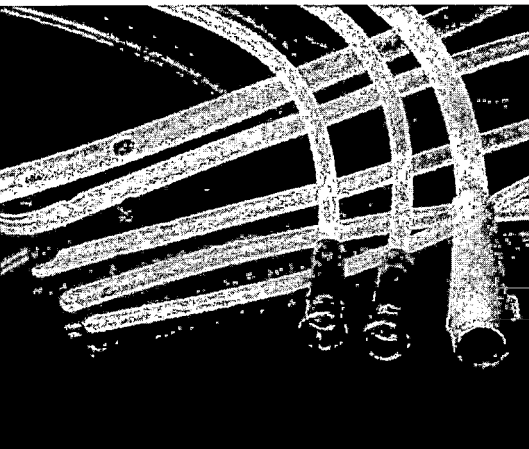

The purpose of the project: To construct the factory to produce disposable medical products from polymers



Implementation period: 2017 – 2018 years



Required Investments: 5,8 mln. dollars. US



Payback period: 5 years



Employment creation: 200 people

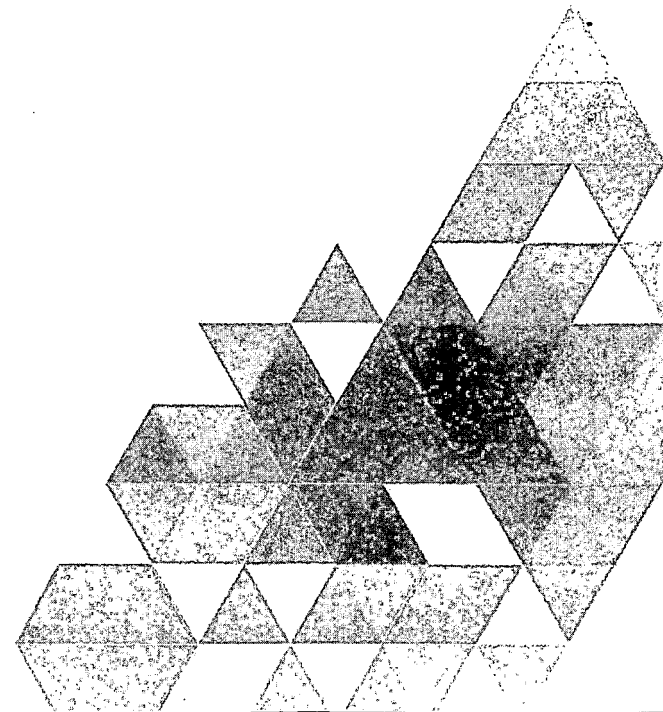



COSMETICS MANUFACTURING

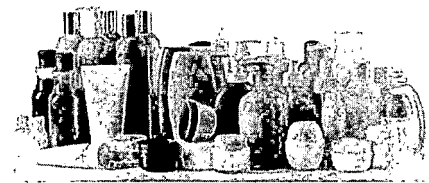
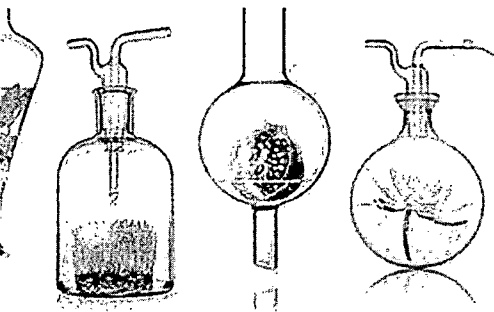

The purpose of the project: To construct the factory to produce cosmetics



Implementation period: 2016 – 2018 years



Required Investments: 4,5 mln. dollars. US



Payback period: 2,5 – 3 years



Need: Imported cosmetics for the period of 10 months in 2015 was in amount of 53,4 million USD



Employment creation: 70 people

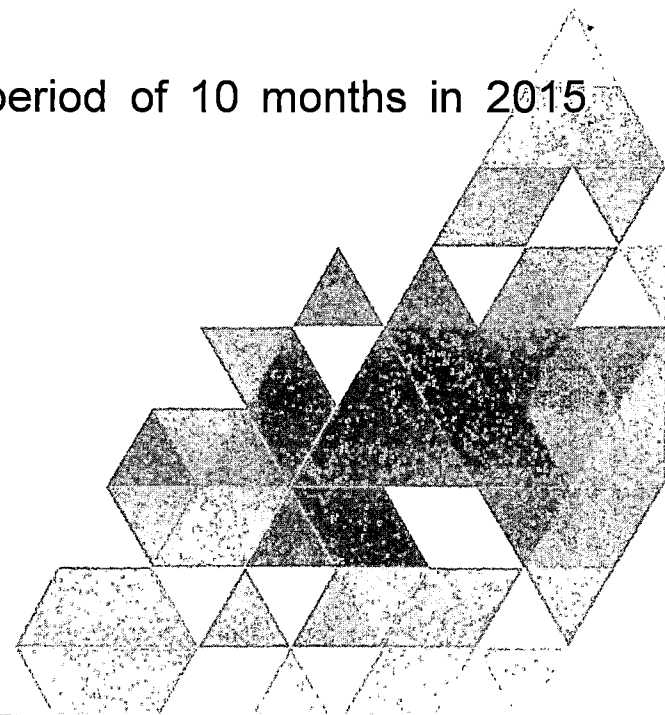

PRODUCTION OF HOUSEHOLD CHEMICALS AND HYGIENE PRODUCTS

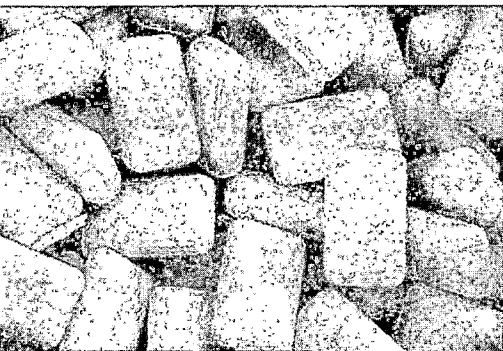

The purpose of the project: Production of household chemicals and hygiene products such as soap, detergent, shaving and oral cavity



Implementation period: 2016 – 2019 years



Required Investments: 12 mln. dollars. US



Payback period: 4 years



Need: Imported number of soaps and detergents for the period of 10 months in 2015 was in amount of 65.7 million USD



Employment creation: 100-150 people

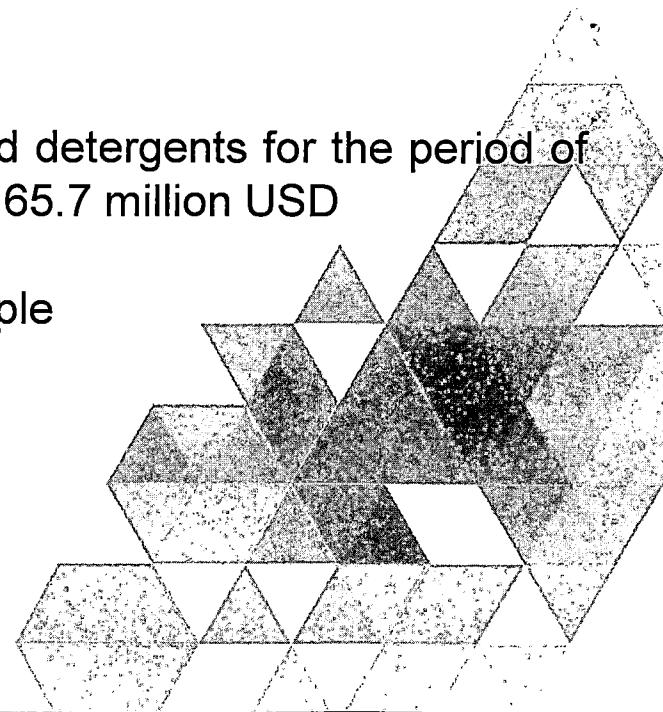



CLOSURES PRODUCTS

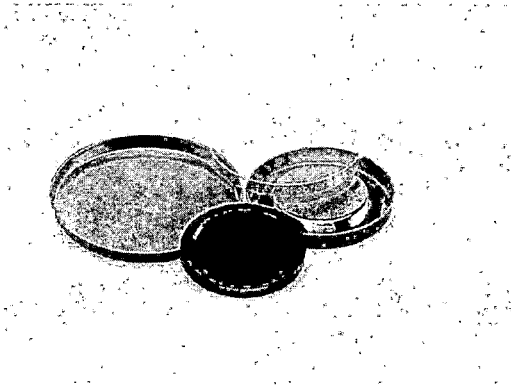
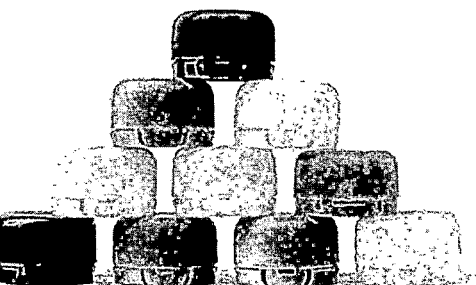

The purpose of the project: The manufacture of covers, caps and other closures production



Implementation period: 2016 – 2017 years



Required Investments: 2 mln. dollars. US



Payback period: 2 years



Need: Imported closure production within 10 month period in 2015 was in amount of 38.6 million USD



Employment creation: 50 people

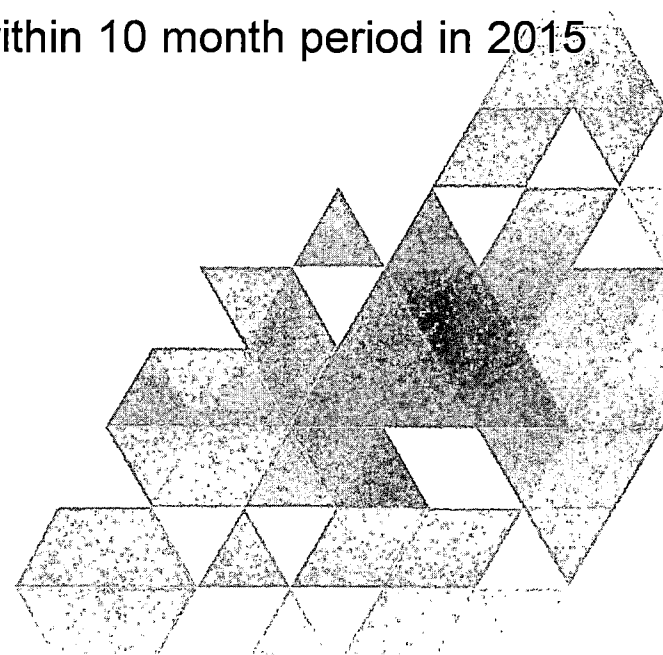

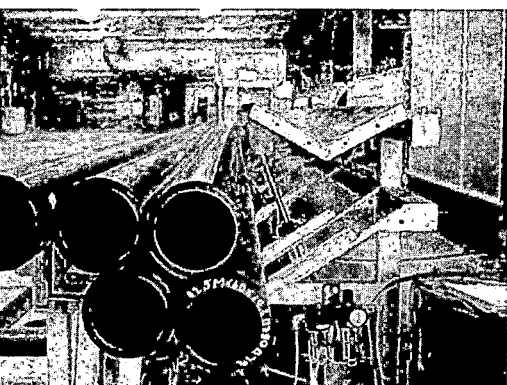
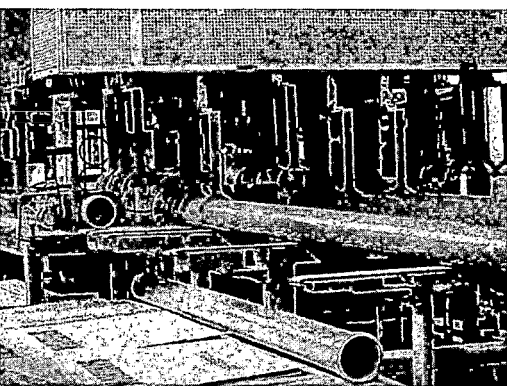
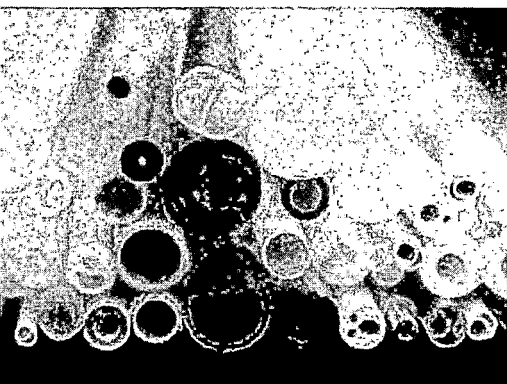

The purpose of the project: Plastic tubes and pipes manufacture implementation



Implementation period: 2016 – 2017 years



Required Investments: 1,8 mln. dollars. US



Payback period: 2,5 – 3 years



Need: Imported plastic tubes for 10 month period in 2015 was in amount of 40.2 million USD



Employment creation: 80 people

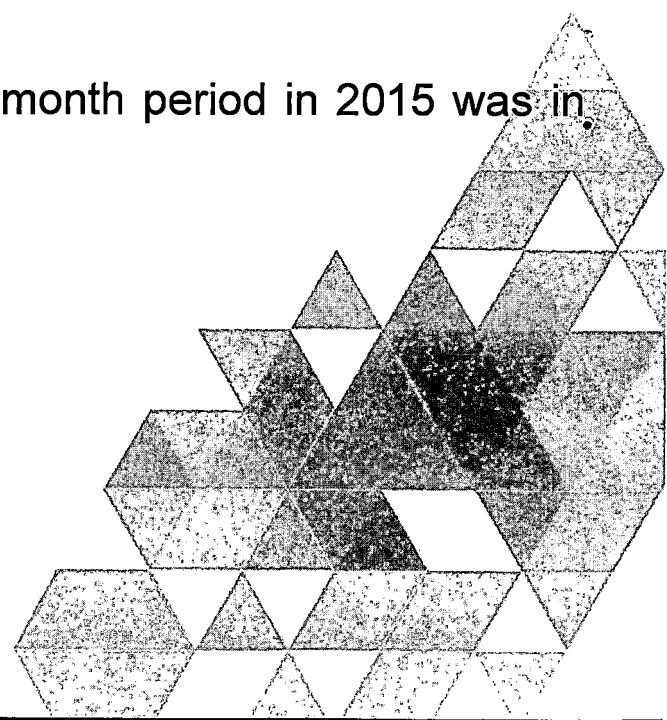



FIXING TOOLS PRODUCTS

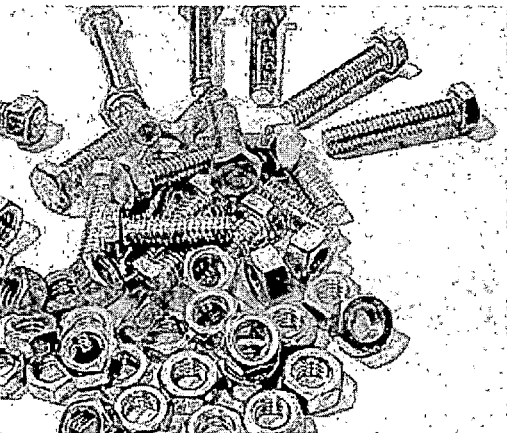
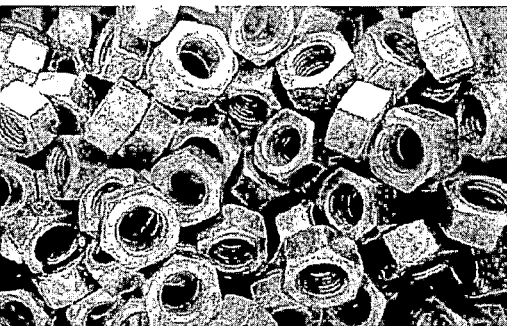
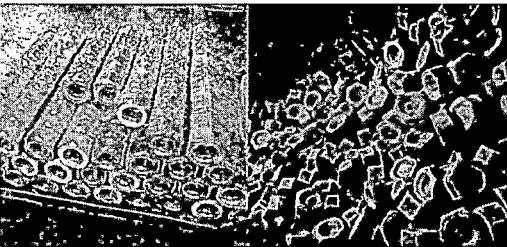

The purpose of the project: Manufacture of fasteners such as screws, bolts, nuts, coach screws, rivets, washers, etc.



Implementation period: 2016 – 2017 years



Required Investments: 15 mln. dollars. US



Payback period: 5 – 6 years



Need: Imported number of fasteners for the 10 month period in 2015 was in amount of 19.1 million. dollars. US



Employment creation: 100-110 people

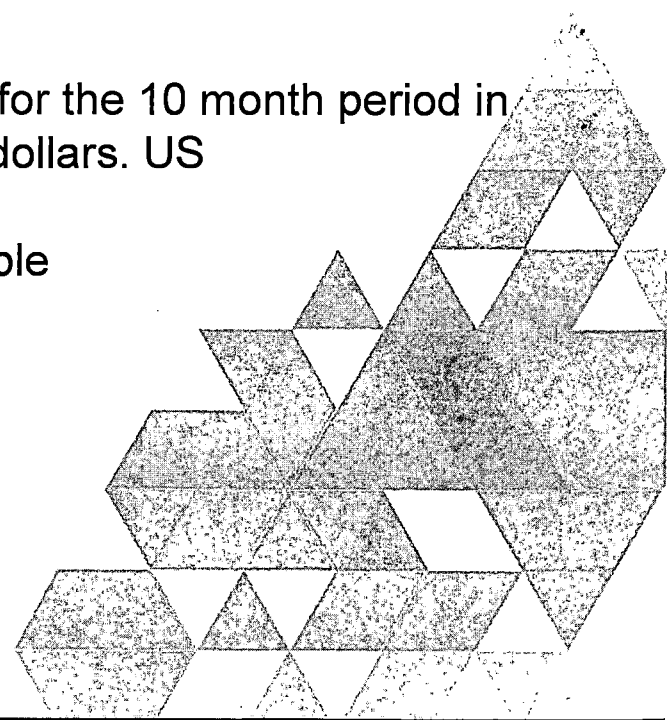



AIR CONDITIONING MANUFACTURER

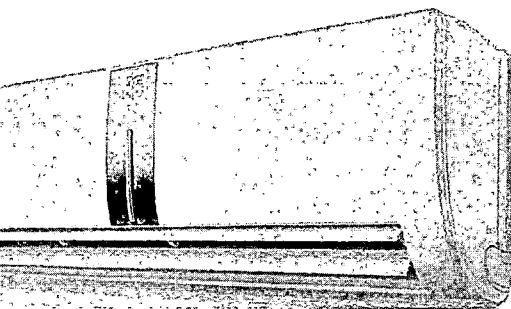

The purpose of the project: Air conditioning manufacturer implementation



Implementation period: 2016 – 2018 years



Required Investments: 2 mln. dollars. US



Payback period: 3 years



Need: The imported number of air conditioning products for the 10 month period in 2015 was in amount of 61.4 million USD



Employment creation: 40 people

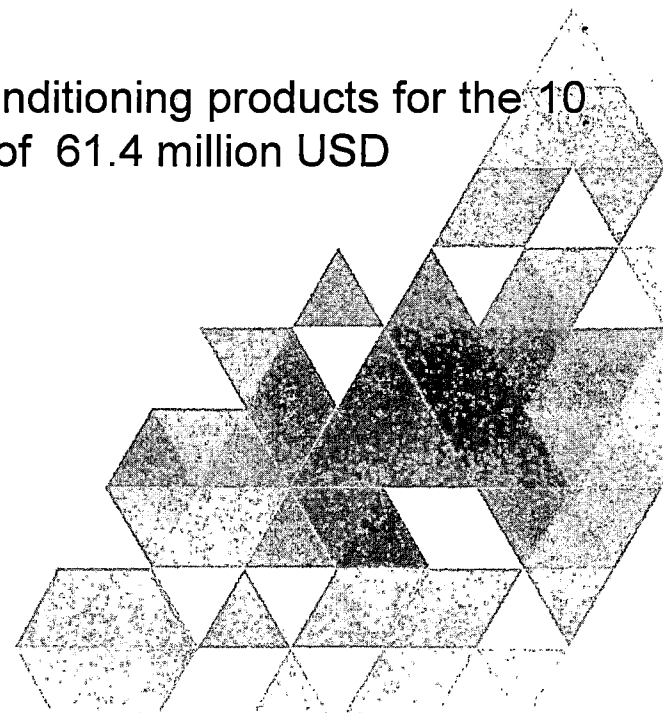
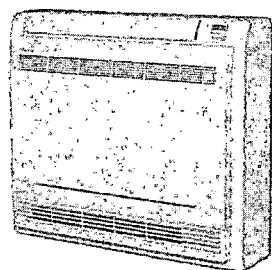
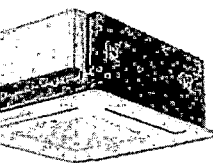
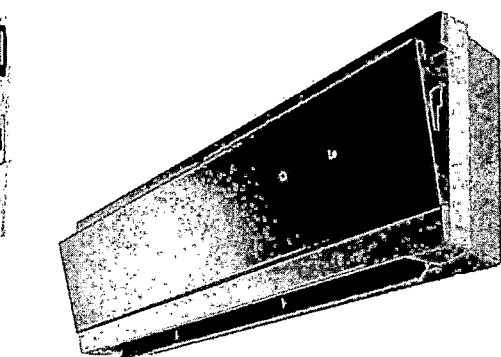

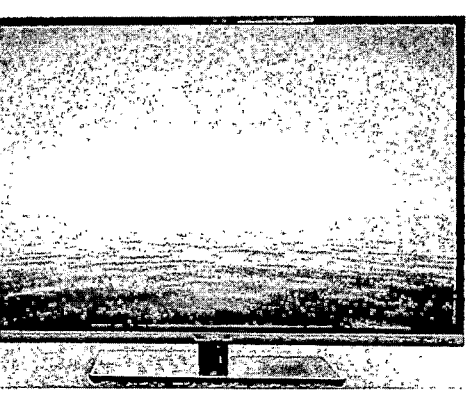
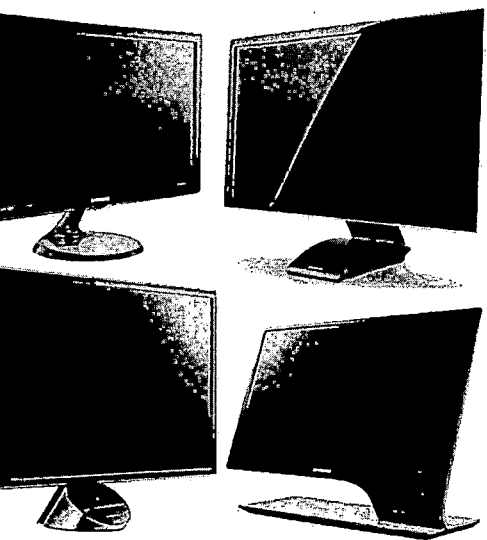

The purpose of the project: To construct the factory to produce monitors and televisions, and the establishment of a research laboratory (R & D) in the special economic zone "Park of innovative technologies"



Implementation period: 2016 – 2020 years



Required Investments: 10 mln. dollars. US



Payback period: 3 years



Advantages:

- There is a partner of JSC «Glotur DS Multimedia»
- There is available space area 9886 m2 in the territory of FEZ "Park of innovative technologies"



Employment creation: 200 people

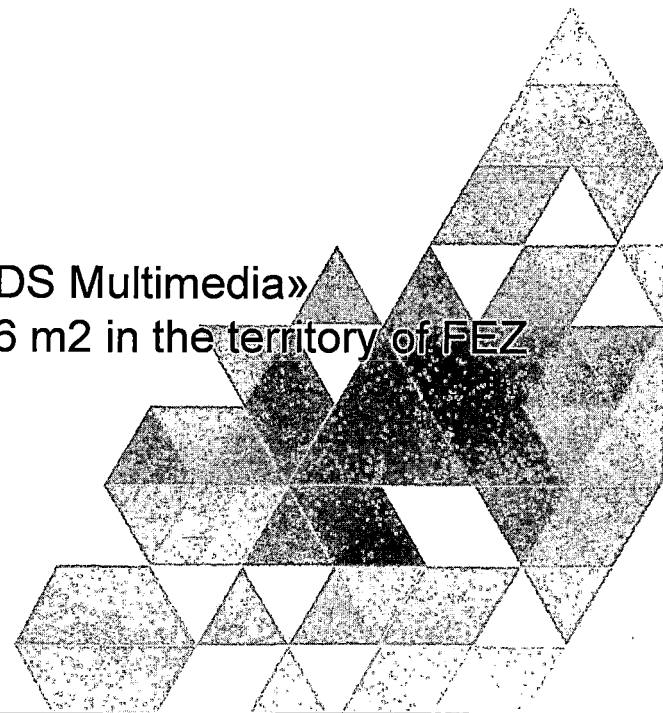

REFRIGERATORS ASSEMBLY

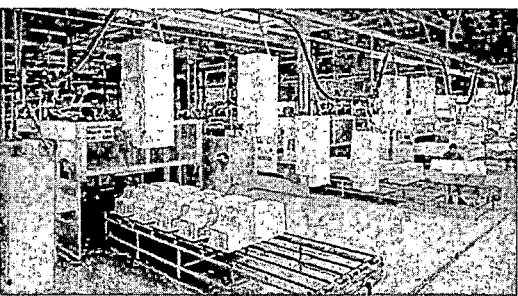
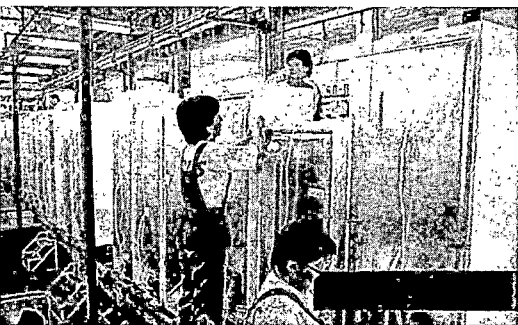
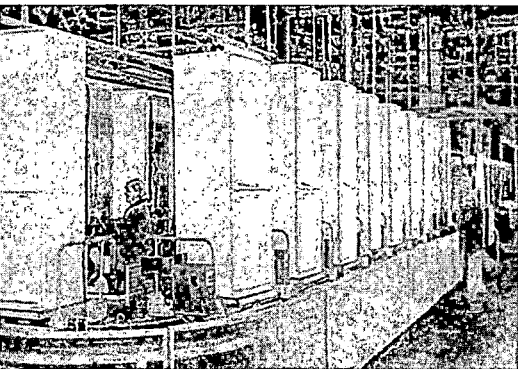

The purpose of the project: Organization of assembling refrigerators and freezers



Implementation period: 2016 – 2018 years



Required Investments: 13 mln. dollars. US



Payback period: 6 years



Need: The imported number of Refrigerators and Freezers for 10 month period in 2015 was in amount of 151,2 million USD



Employment creation: 90 people

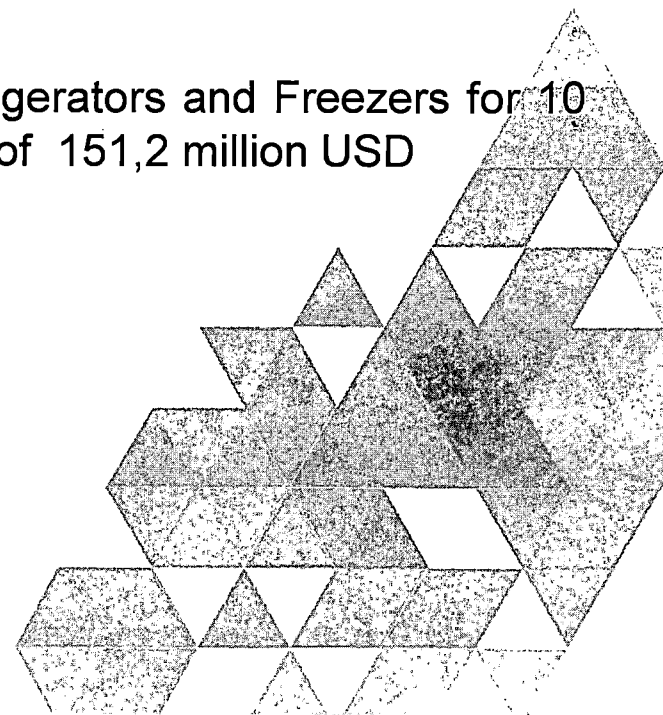

ASSEMBLY WASHING MACHINES

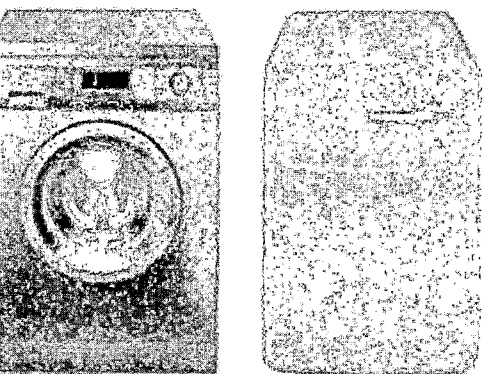
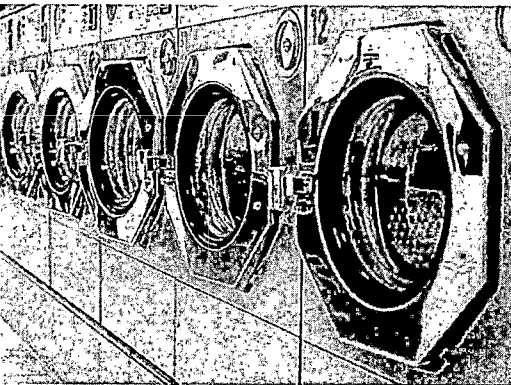
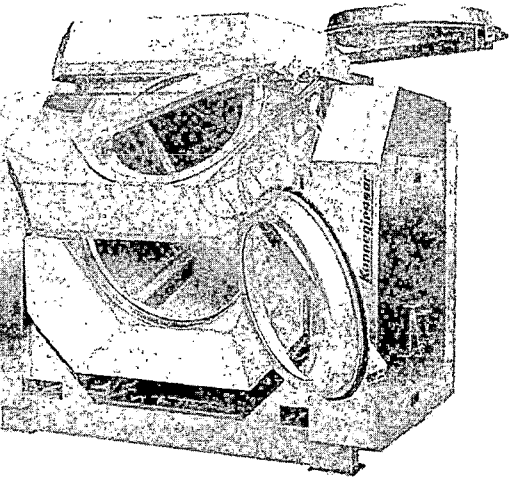

The purpose of the project: To assemble household and laundry washing machines



Implementation period: 2016 – 2018 years



Required Investments: 8 mln. dollars. US



Payback period: 5 years



Need: The imported number of washing machines for 10 month period in 2015 was in amount of 16,2 million USD



Employment creation: 70 people

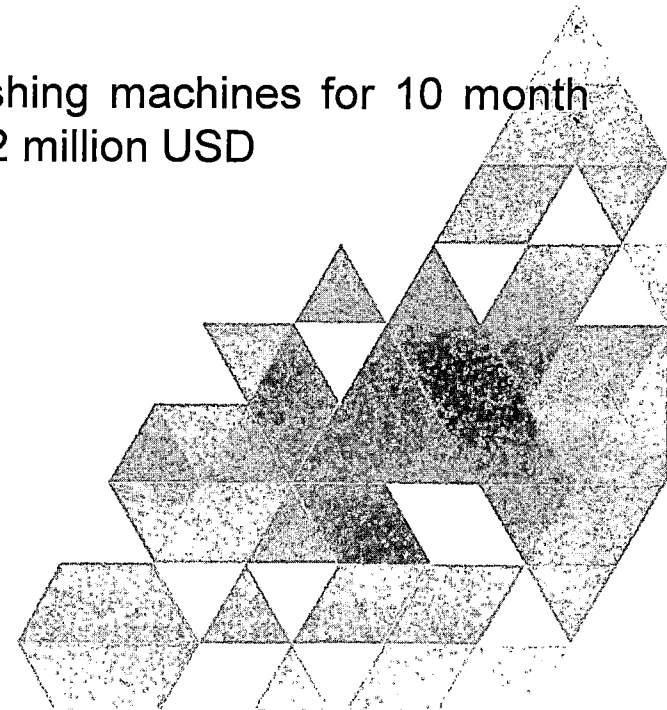

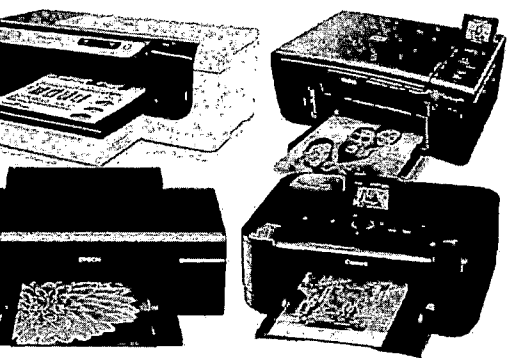
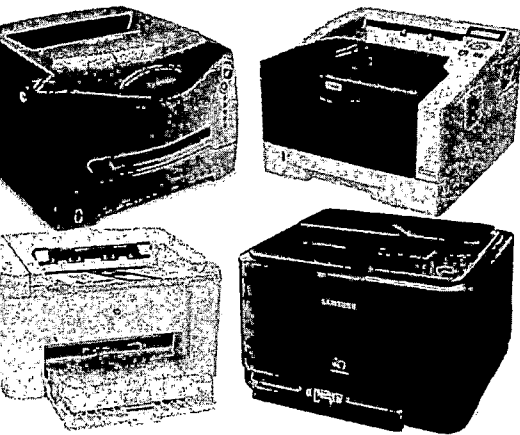
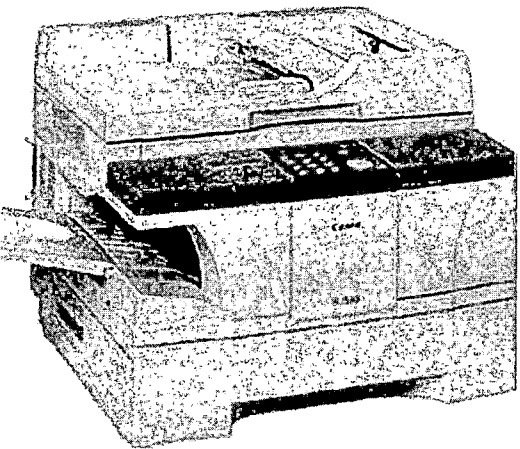

The purpose of the project: Presses, printers, copiers and fax machines assembly



Implementation period: 2016 – 2018 years



Required Investments: 11 mln. dollars. US



Payback period: 4 years



Need: The imported number of printing machines for 10 month period in 2015 was in amount of 16,2 million USD



Employment creation: 50 people

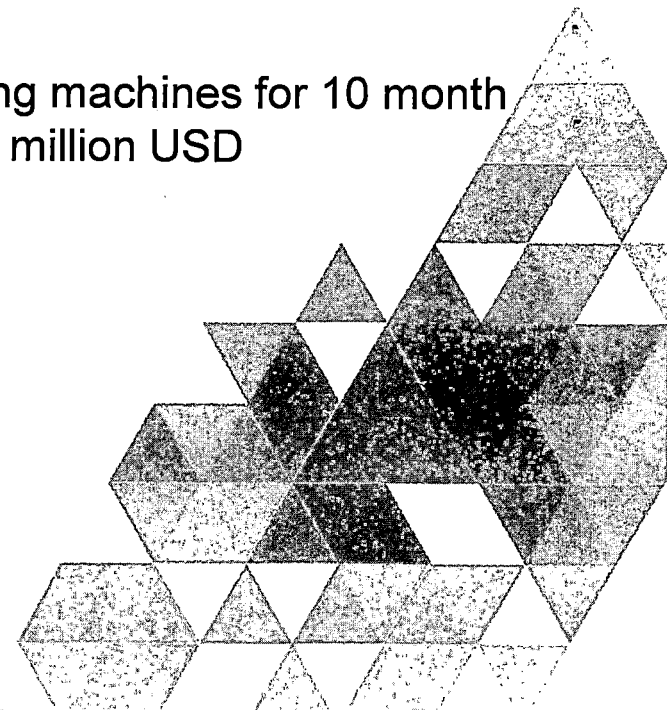

FILTERS PRODUCTION

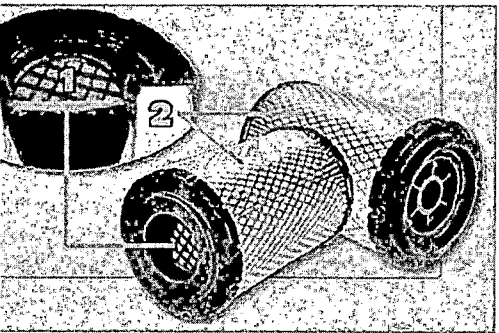
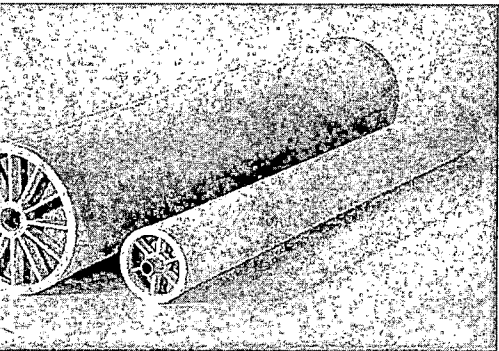
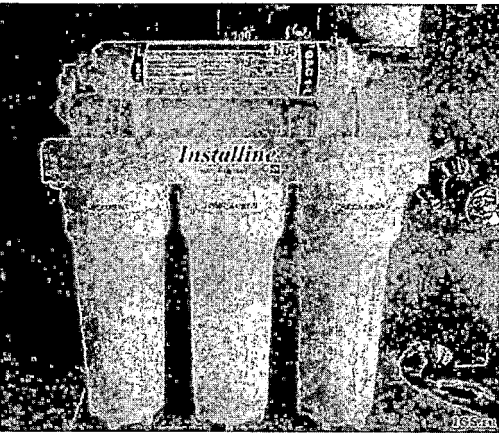

The purpose of the project: Filters manufacturing for liquids and gases purification



Implementation period: 2016 – 2017 years



Required Investments: 800 mln. dollars. US



Payback period: 2 years



Need: The imported number of Filters for 10 month period in 2015 was in amount of 68,1 million USD



Employment creation: 20 people

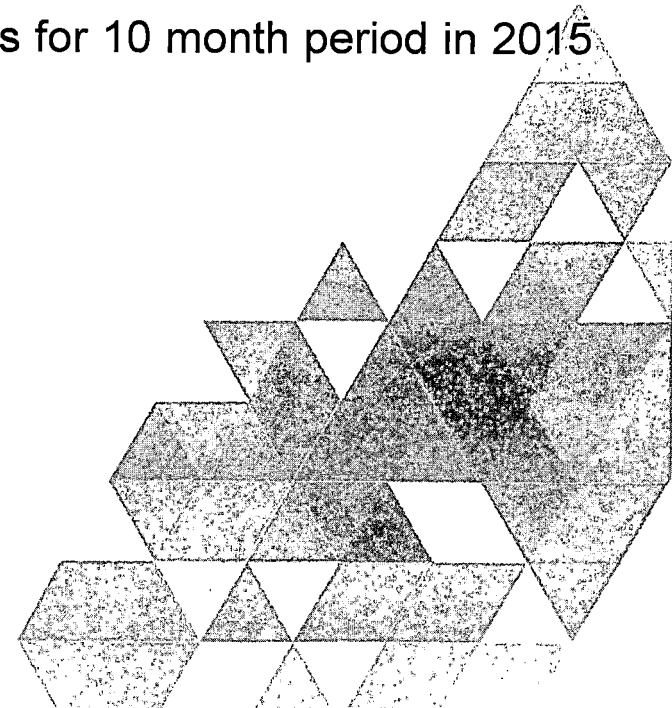

MANUFACTURE OF LIFTING EQUIPMENT

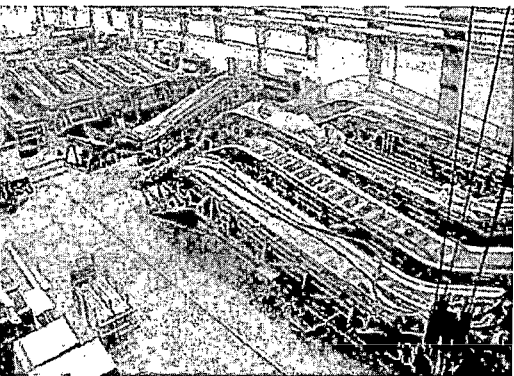
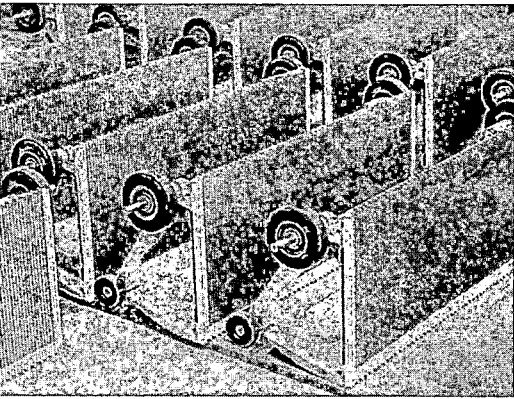

The purpose of the project: production of elevators, escalators, conveyors



Implementation period: 2016 – 2019 years



Required Investments: 4 mln. dollars. US



Payback period: 4 years



Need: The imported number of lifting equipment for 10 month period in 2015 was in amount of 68,1 million USD



Employment creation: 60 people

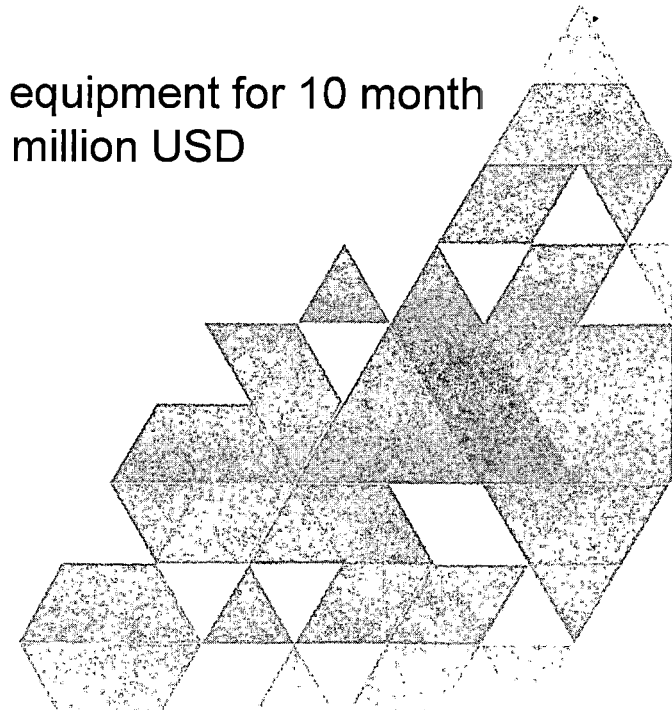

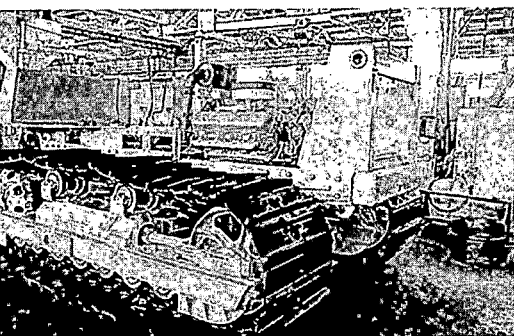
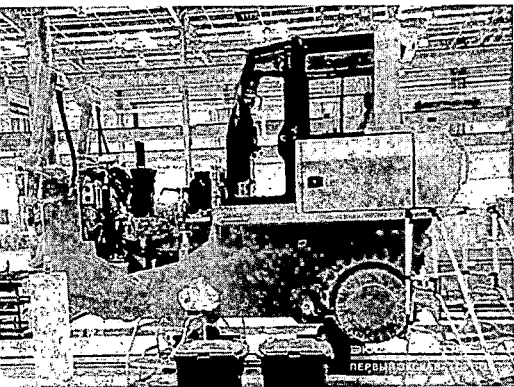

The purpose of the project: service center of heavy industry machinery repair and maintenance



Implementation period: 2016 – 2019 years



Required Investments: 2,5 mln. dollars. US



Payback period: 2 years



Need: There is no certified service center in the territory of Kazakhstan



Employment creation: 70 people

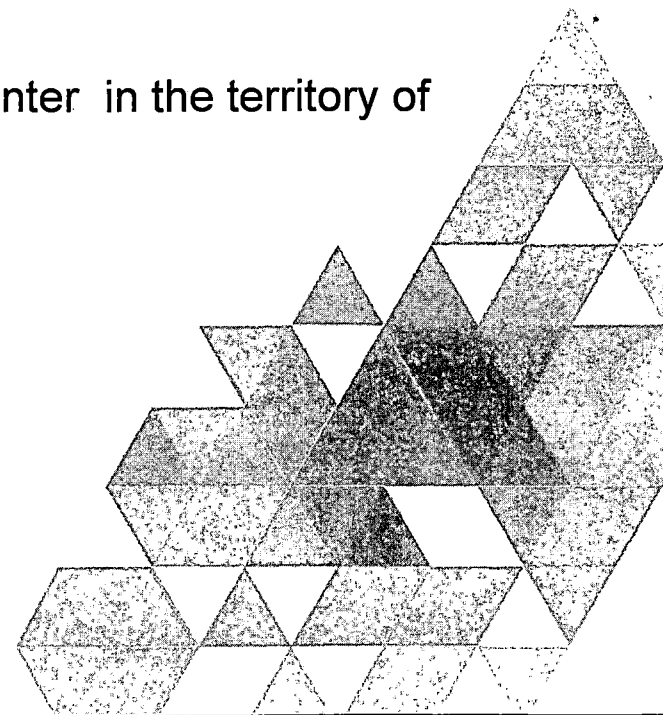

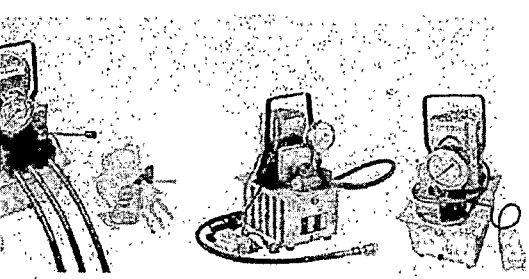
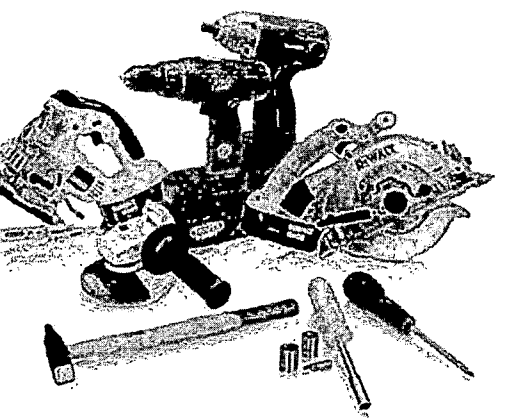
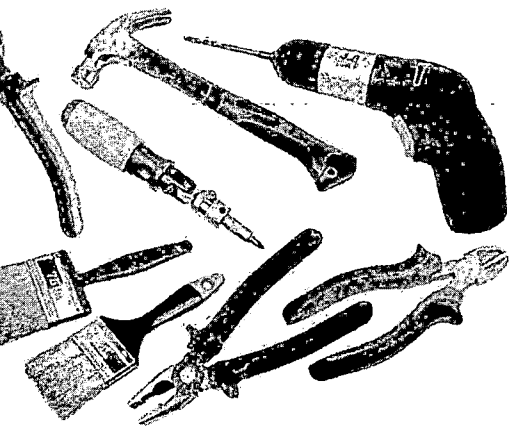

The purpose of the project: Manual, pneumatic and hydraulic construction tools production



Implementation period: 2016 – 2018 years



Required Investments: 5 mln. dollars. US



Payback period: 4 years



Need: The imported number of construction tools for 10 month period in 2015 was in amount of 24,4 million USD



Employment creation: 46 people

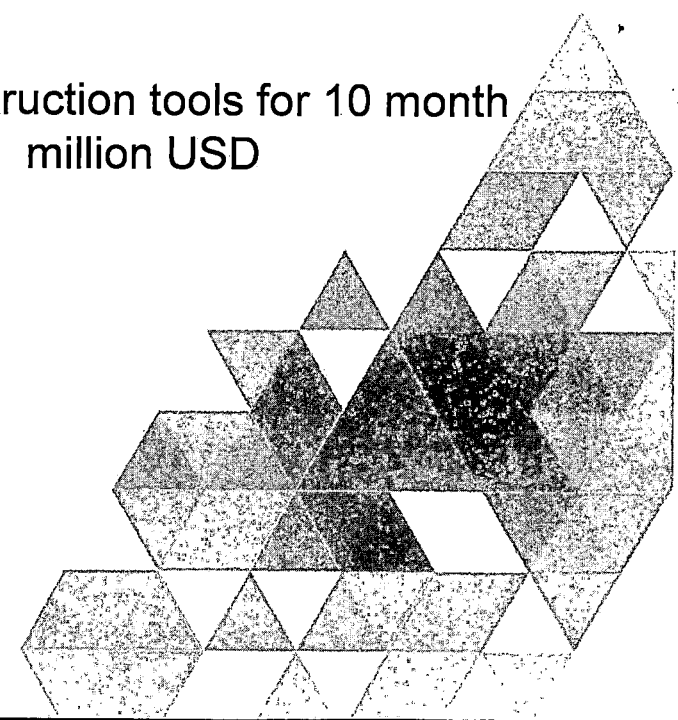

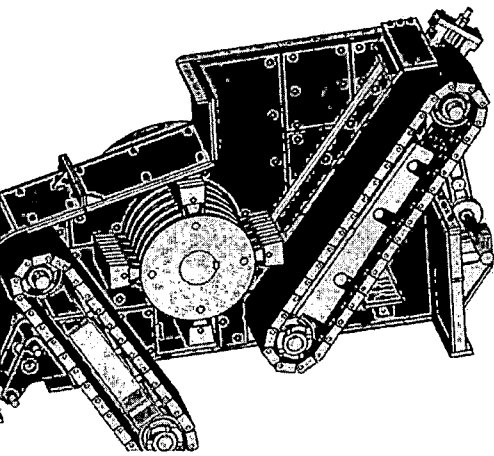
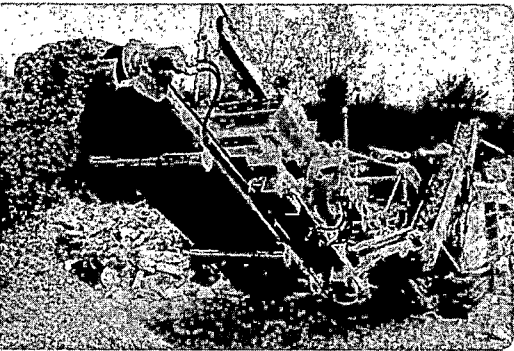
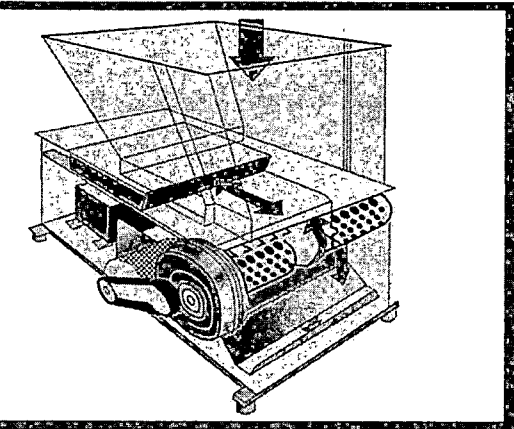

The purpose of the project: Production equipment for sorting, washing, grinding, mixing of gravel, stone and ores



Implementation period: 2016 – 2018 years



Required Investments: 15 mln. dollars. US



Payback period: 7 years



Need: The imported number of equipment for working with gravel, stone and ore for 10 month period in 2015 was in amount of 136,7 million USD



Employment creation: 130 people

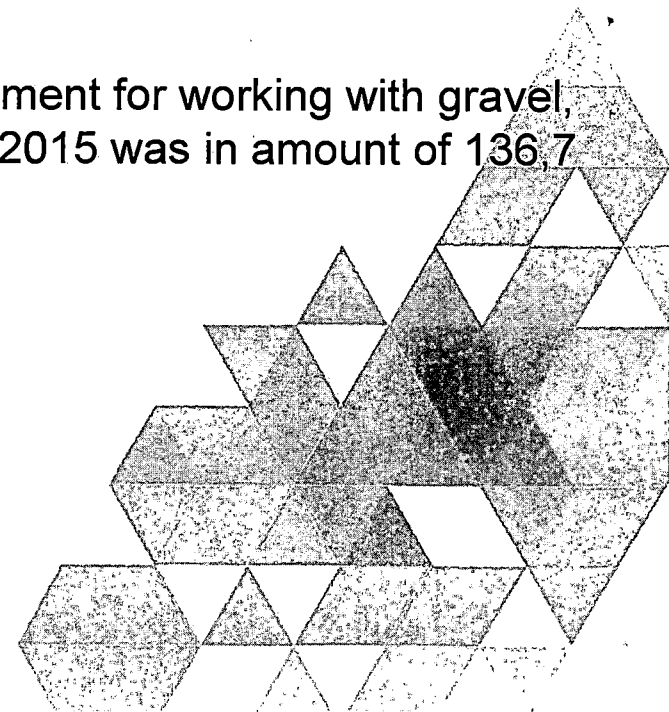

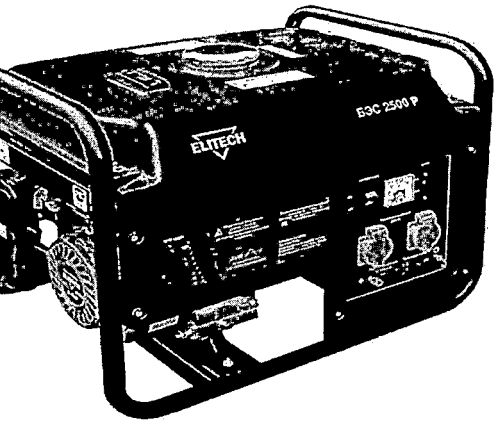

The purpose of the project: power generators with rotary converters production



Implementation period: 2016 – 2017 years



Required Investments: 5 mln. dollars. US



Payback period: 5-6 years



Need: import power generators for 10 months of 2015 amounted to 39.5 million. dollars. US



Employment creation: 50-60 people

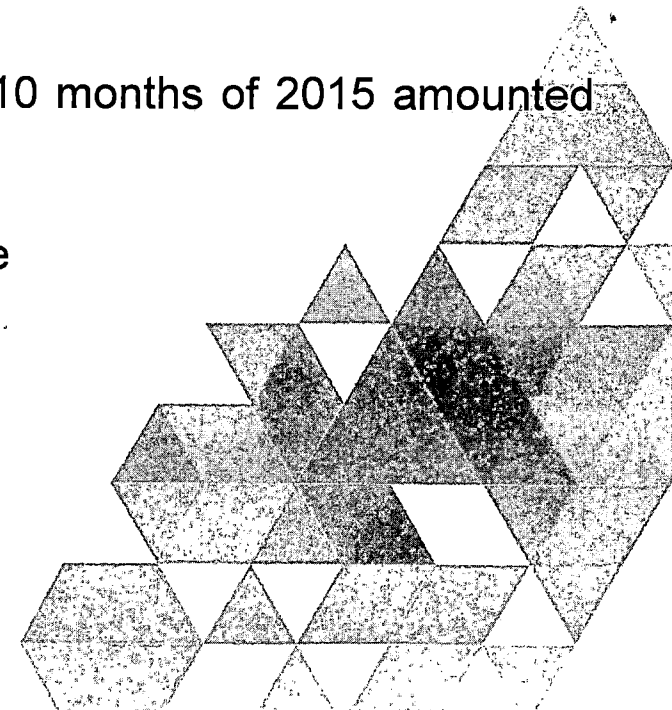
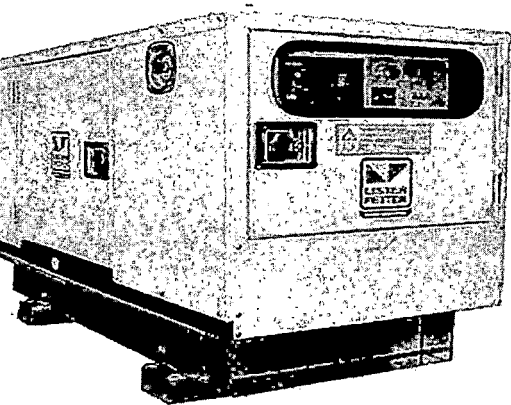
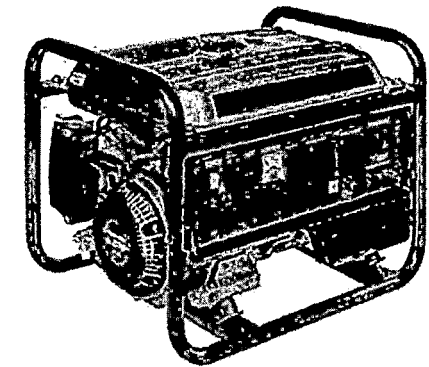

TRANSFORMERS PRODUCTION

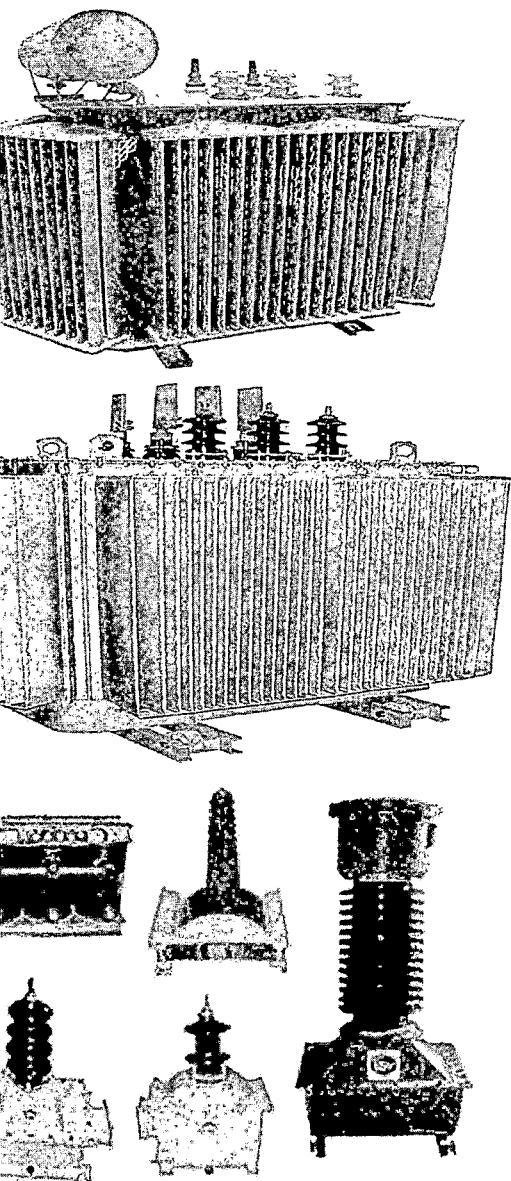

The purpose of the project: electrical transformers including set parts manufacturing



Implementation period: 2016 – 2020 years



Required Investments: 30 mln. dollars. US



Payback period: 5 years



Need: Import transformers for 10 months of 2015 amounted to 75.1 million. Dollars. US



Employment creation: 200 people

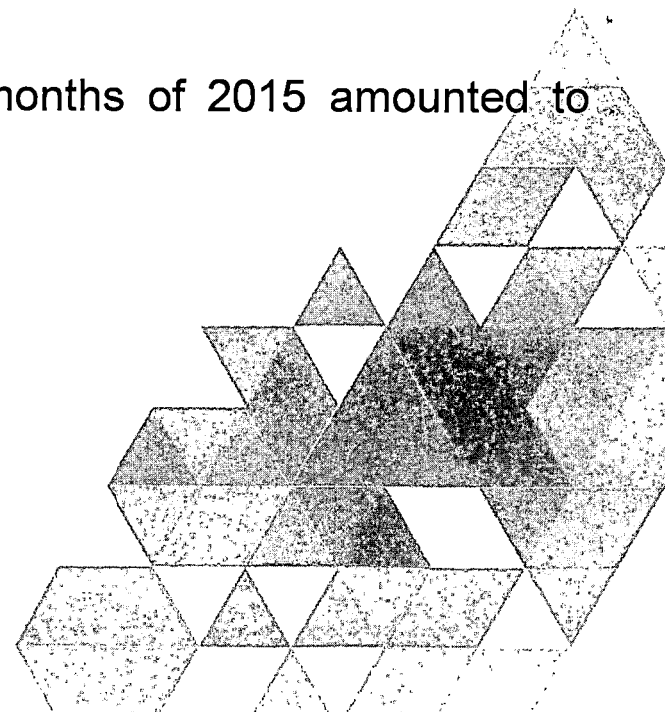

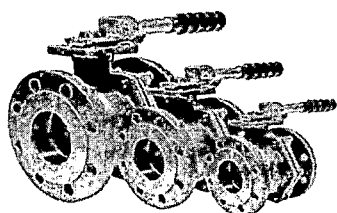
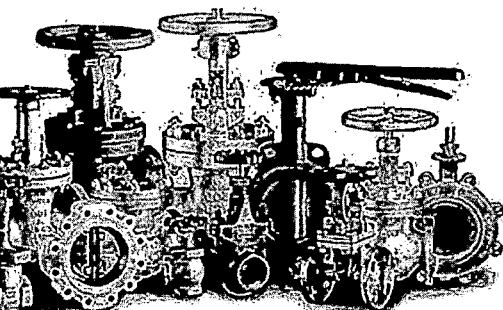
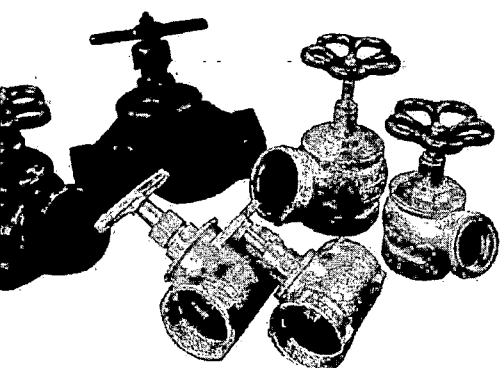

The purpose of the project: automated valves, valves, fittings and valves for pipelines fabrication



Implementation period: 2016 – 2017 years



Required Investments: 7 mln. dollars. US



Payback period: 4,5 years



Need: Import of taps and valves for 10 months of 2015 amounted to 126.5 million. dollars. US



Employment creation: 90 people

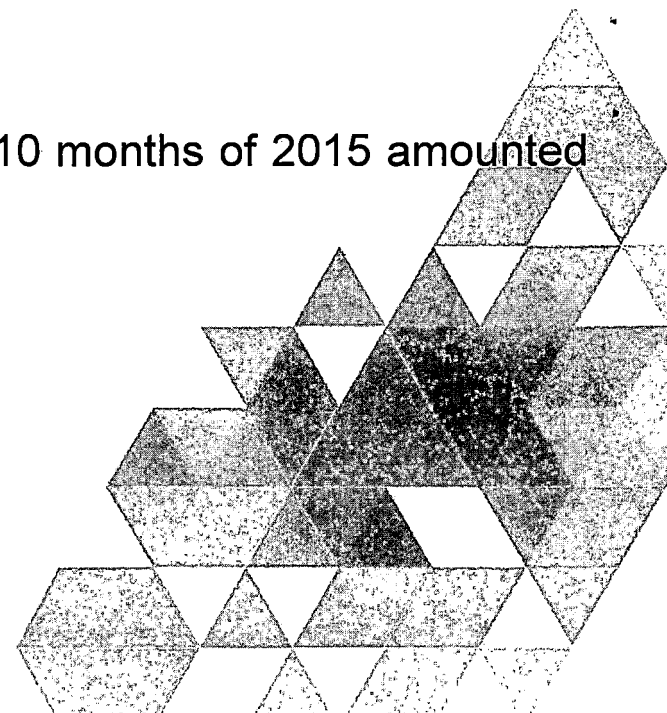

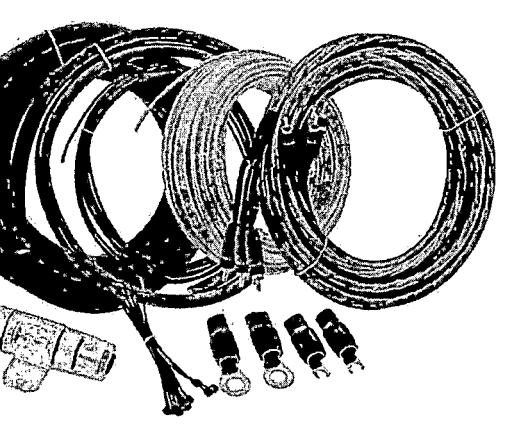
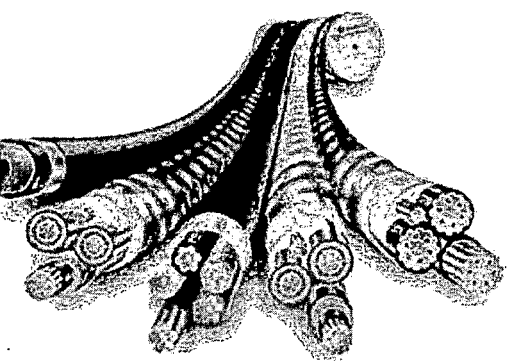
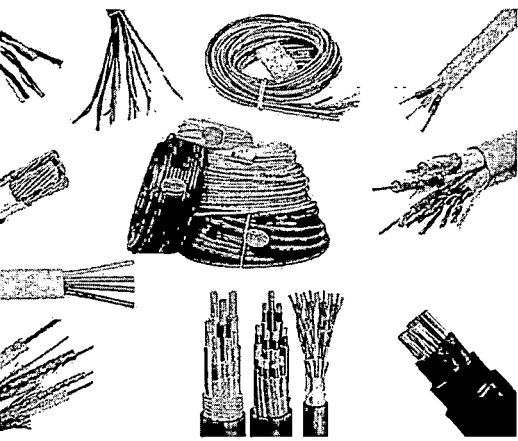

The purpose of the project: To construct the factory to produce cables and insulated wires



Implementation period: 2016 – 2019 years



Required Investments: 125 mln. dollars. US



Payback period: 4 years



Need: Import insulated wires for 10 months of 2015 62.4 mln. USD



Employment creation: 250 people

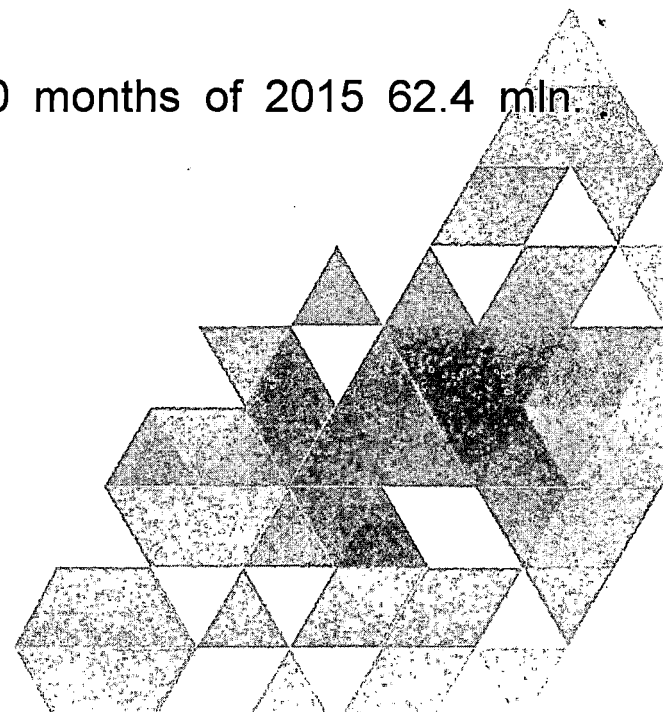

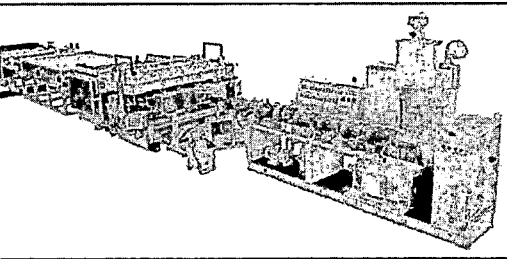
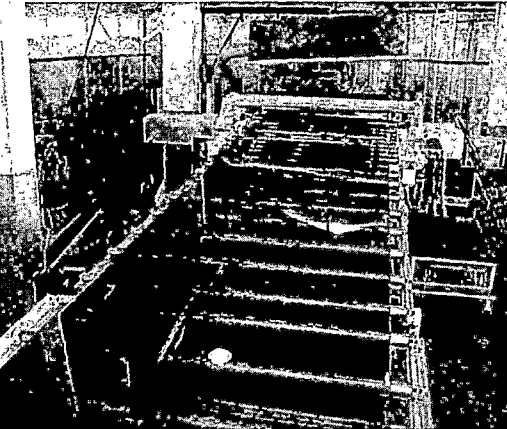
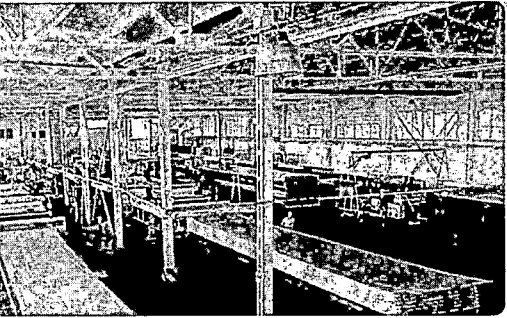

The purpose of the project: To construct the factory to produce roofing material - polycarbonate



Implementation period: 2016 – 2017 years



Required Investments: 1,5 mln. dollars. US



Payback period: 2,5 years



Employment creation: 20 people

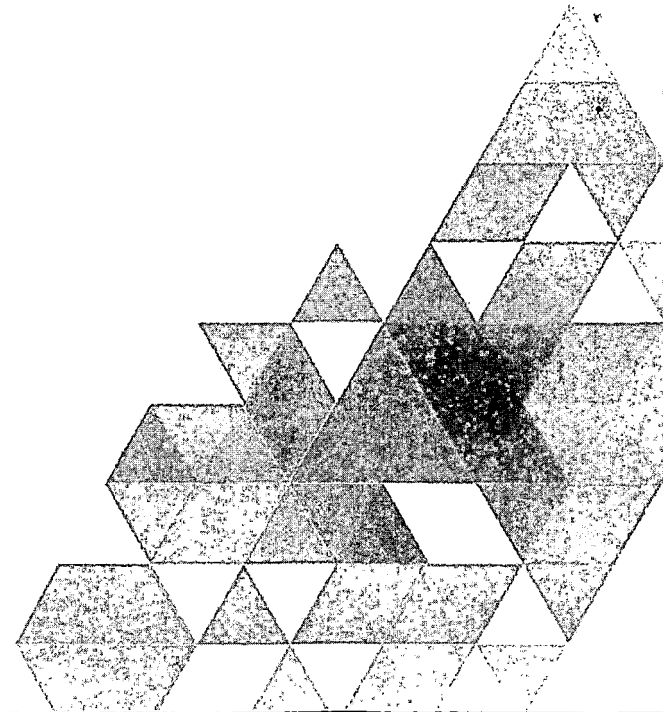

PRODUCTION OF GAS BOILERS

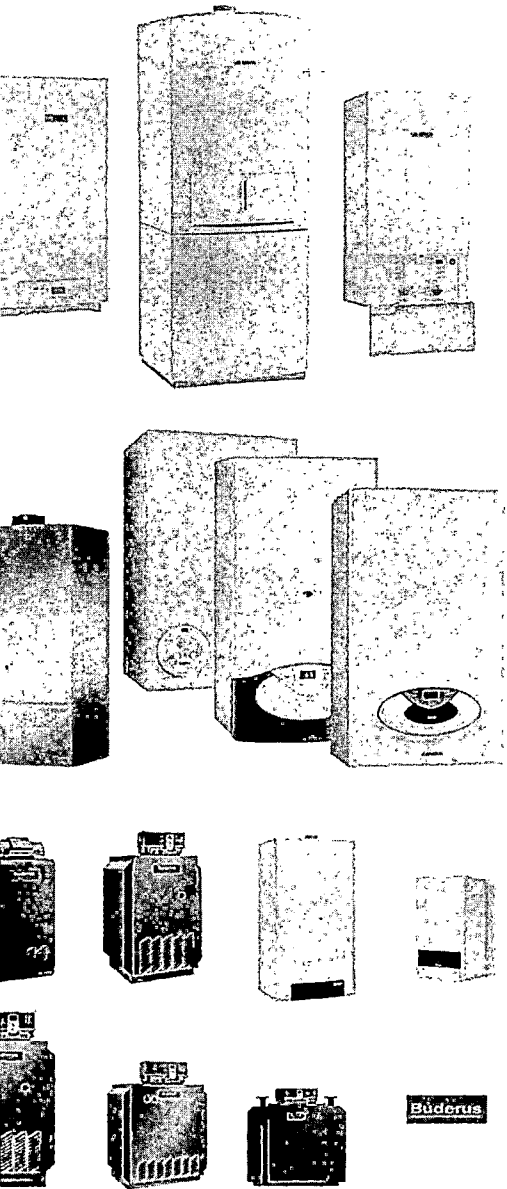

The purpose of the project: Production of gas boilers for heating



Implementation period: 2016 – 2018 years



Required Investments: 1 mln. dollars. US



Payback period: 5 years



Employment creation: 50 people

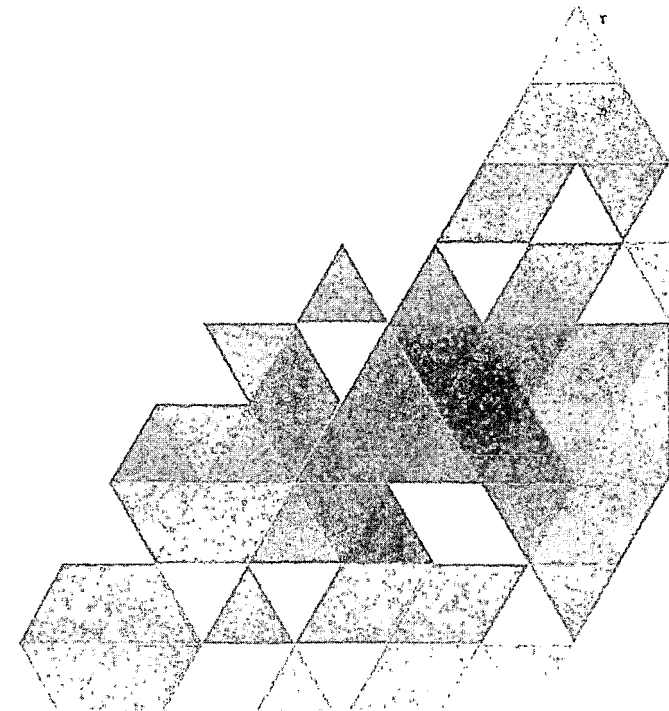

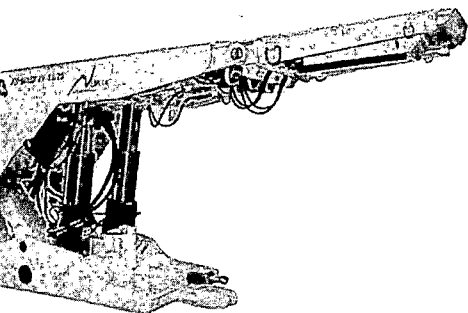
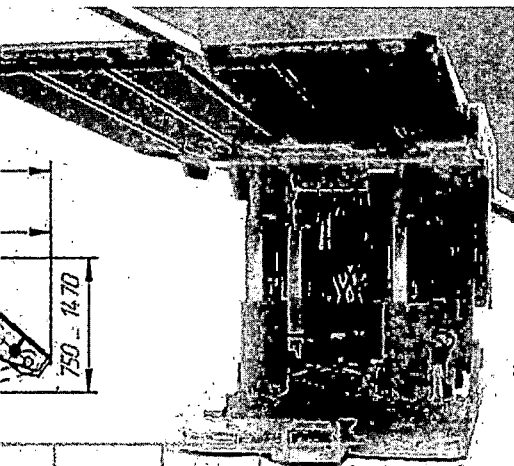
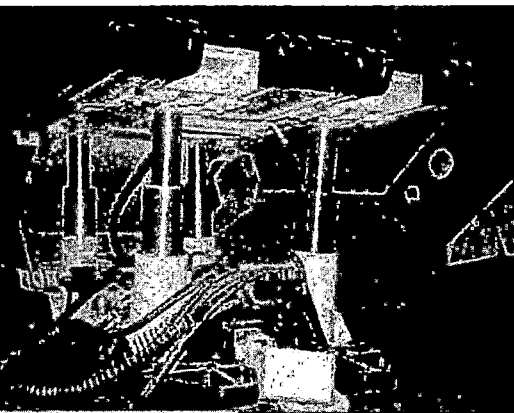

The purpose of the project: manufacturing mechanical mine roof supports for supporting mine tunnels



Implementation period: 2016 – 2019 years



Required Investments: 10 mln. dollars. US



Payback period: 6 years



Need: There are no producers in Kazakhstan, so the equipment in amount of 404 mln USD has been purchased for the last 5 years



Employment creation: 150 people

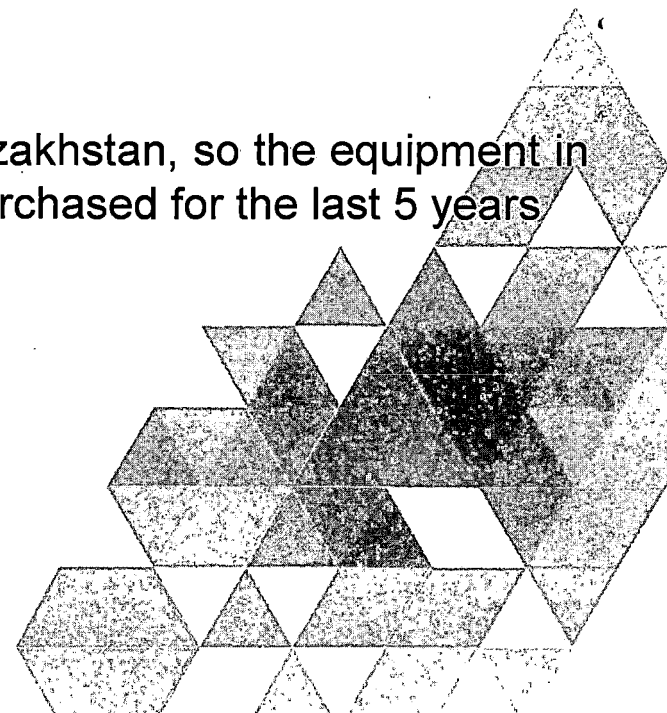

CARGO TRAILER PRODUCTION

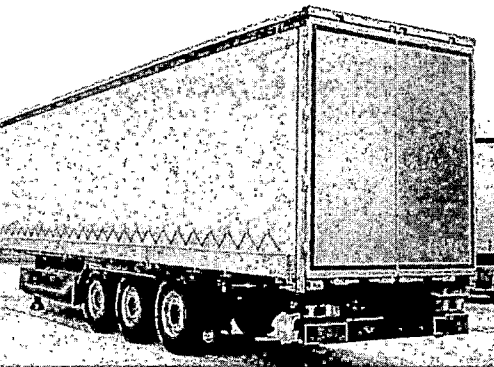
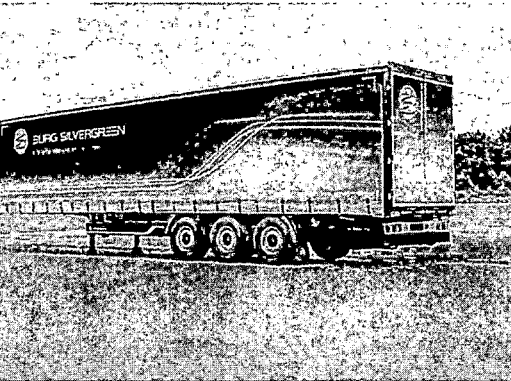
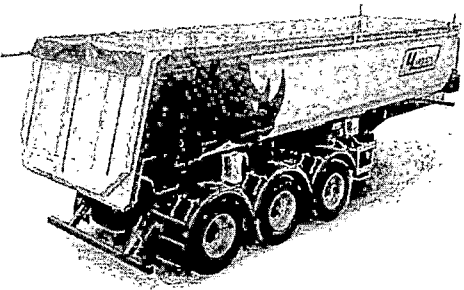

The purpose of the project: Fabrication of Cargo/Fournier Trailers with capacity more than 20 tons



Implementation period: 2016 – 2019 years



Required Investments: 600 mln. dollars. US



Employment creation: 300 people



Need: There is lack of cargo trailers in the territory of the Republic of Kazakhstan. Import into the Republic of Kazakhstan has been 11 000 units for the last 3 years

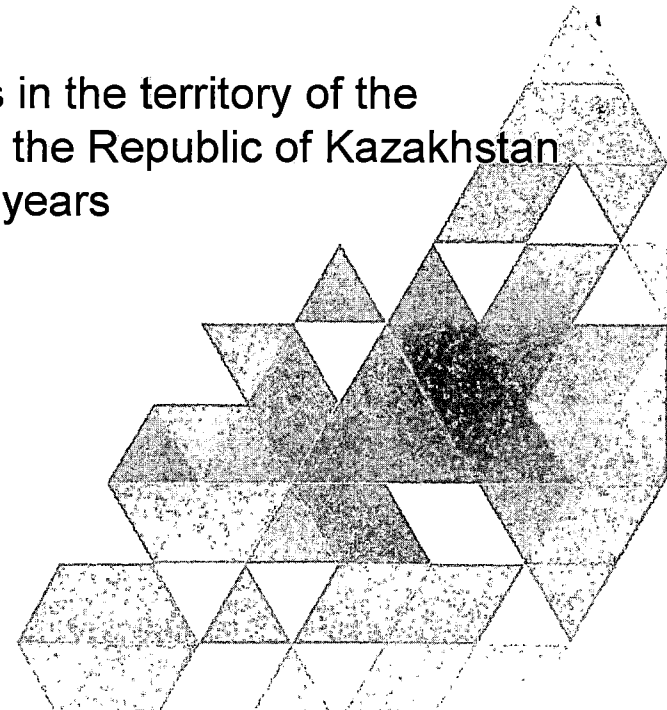

CONTAINER PRODUCTION

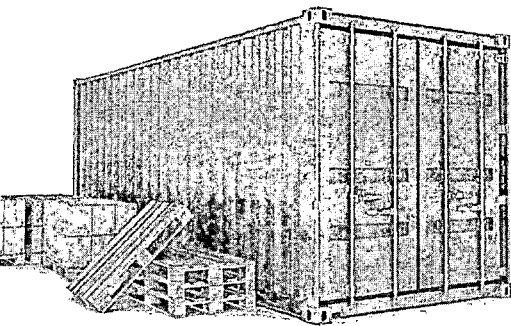
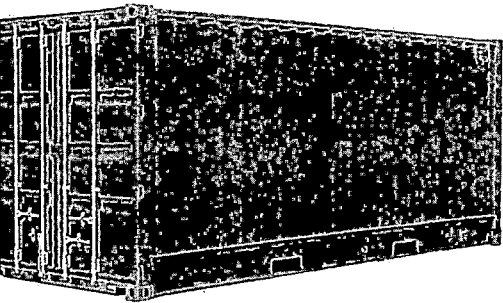
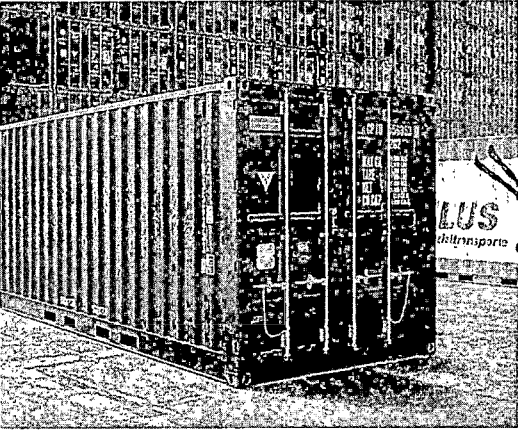

The purpose of the project: metal and sea transport containers
Fabrication



Implementation period: 2016 – 2018 years



Required Investments: 5 mln. dollars. US



Payback period: 5 years



Need: There are no producers in Kazakhstan. There has been increase in exports of products transported inside of containers



Employment creation: 150 people

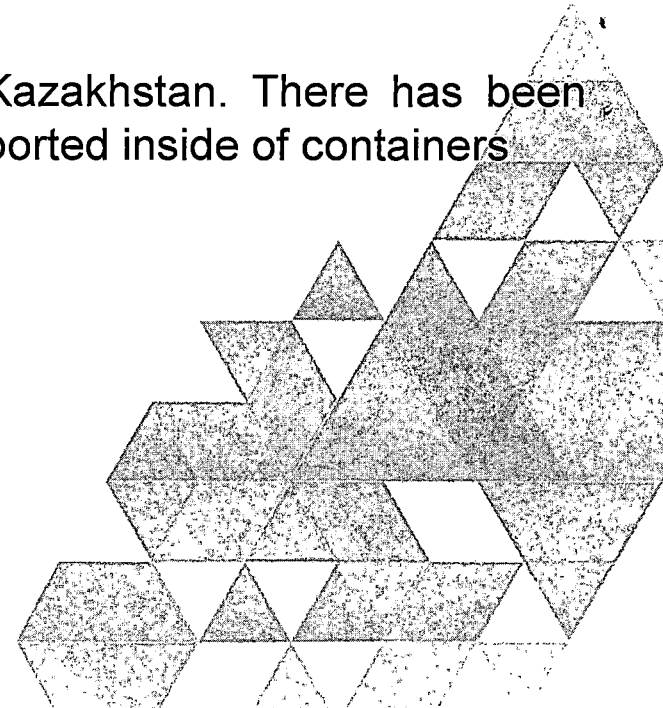



Zhanna Galymova

Deputy Chairman of Business and Industrial Innovations Development Department in Almaty City

mobile.: +7 (702) 7023137
office.: (727) 271-65-32
email: janna2808@gmail.com

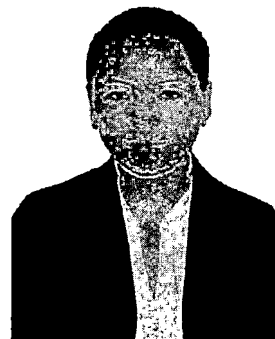

Zhibek Nurtanova

Chairman of Business and Industrial Innovations Development Department in Almaty City

mobile.: +7 (701) 9000070
office.: (727) 271-65-89
email: nurtanova.z@gmail.com



Arsen Nasyrkhanov

Chairman of Investor Service Center

mobile.: +7 (777) 2773727
email: nad.pest@mail.ru



Altynay Mukanova

Deputy Chairman of Investor Service Center

mobile.: +7 (775) 1231019
email: altokaenu@mail.ru



Madiyar Daniyarov

Manager Investor Service Center

mobile.: +7 (701) 3976171
email: madiyarkhan@gmail.com



Serikzhan Mukhtarov

Manager Investor Service Center

mobile.: +7 (702) 4228553
email: m.s.g.t@mail.ru

